

HR FRITEZA NA VRUĆI ZRAK	2	LV AIRFRYER	49	SV LUFTFRITÖS	91
CS ELEKTRICKÁ FRITÉZA	6	LT „AIRFRYER“	54	TR YAĞSIZ FRITÖZ	95
DA AIRFRYER	11	NO AIRFRYER	59	UK МУЛЬТИПІЧ	100
EN AIRFRYER	15	PL FRYTKOWNICA BEZTŁUSZCZOWA		AR مقلاة هوائية	108
ET KUUMAÕHUFRITÜÜR	20		63		
FI ILMAKYPSENNIN	25	RO FRITEUZĂ CU AER	68		
FR FRITEUSE À AIR	29	RU АЭРОГРИЛЬ	73		
DE HEISSLUFTFRITTEUSE	34	SR FRITEZA BEZ ULJA	78		
HU FORRÓLEVÉGŐS SÜTŐ	39	SK AIRFRYER	83		
IT FRIGGITRICE AD ARIA	44	SL AIRFRYER	87		

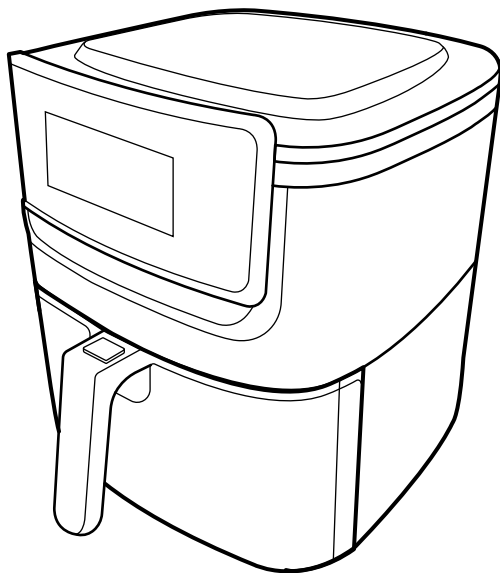

1. OPĆI PREGLED

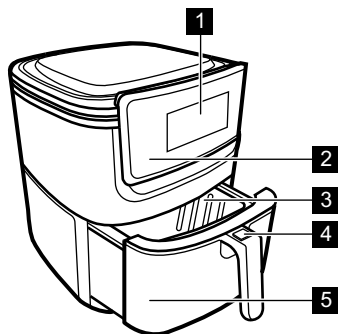

- 1** Zaslون
- 2** Upravljačka ploča
- 3** Košara
- 4** Sigurnosno zaključavanje sa zaštitnim poklopcem
- 5** Plitica

2. UPRAVLJAČKA PLOČA

2.1 Upravljačka ploča

Upoznajte se s osnovnim ikonama na upravljačkoj ploči i zaslonu.

UKLJ./ISKLJ.	Gore	Dolje	Temperatura	Trajanje

Pomoć pri kuhanju - kuhanje s automatskim postavkama vremena i temperature.

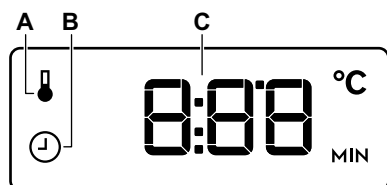

Riba	Odrezak	Pileći bataci	Pile
Povrće	Pomfrit	Mini pizza	Muffini

2.2 Zaslون



- A.** Postavka temperature
- B.** Postavka vremena
- C.** Vrijeme/temperatura

3. PRIJE PRVE UPORABE

	Uklonite svu ambalažu, naljepnicu i zaštitnu foliju.
	Očistite košaru i posudu toplom vodom, tekućinom za pranje i mekom krpom. Osušite unutarnju i vanjsku stranu uređaja krpom.
	Pri prvoj uporabi, uređaj može ispuštati netoksičan miris koji nestaje odmah. To ne utječe na korištenje.

4. SVAKODNEVNA UPORABA

4.1 Kako koristiti: plitica i košara

Postavite uređaj na stabilnu površinu.

1. Uklonite pliticu i stavite je na stabilnu površinu.
2. Uklonite zaštitni poklopac na sigurnosnoj bravi.
3. Pritisnite sigurnosnu bravu i uklonite košaru.

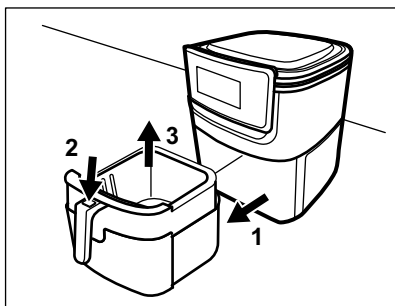

4. U košaru stavite hranu do maksimalne razine. Maksimalna zapremina kkošare je 2 kg.

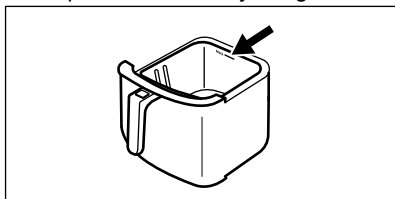

4.2 Kako kuhati

Stavite hranu u košaru. Priključite uređaj na izvor napajanja.

1.  - pritisnite i držite.

2. Odaberite jelo iz Pomoći pri kuhanju:

Simbol	Postavka
	140°C 15 min
	200°C 10 min
	180°C 20 min
	180°C 45 min
	170°C 15 min
	180°C 15 min
	180°C 10 min
	180°C 15 min

3. Pritisnite: .

Po završetku kuhanja, ventilator za hlađenje radi nekoliko sekundi, a zatim se oglašava signal.

Možete promijeniti postavke i isključiti uređaj tijekom kuhanja:









- Za promjenu programa, pritisnite simbol hrane.







- ^, v - pritisnite za podešavanje postavke vremena ili temperature.
- ⏸ - pritisnite i zadržite nekoliko sekundi da isključite uređaj.

Iskopčajte uređaj iz napajanja i pričekajte da se ohladi. Očistite pliticu i košaru.

5. SAVJETI ZA KUHANJE

Temperature i vremena kuhanja u tablicama služe kao primjeri. Ovisе o receptima, kvaliteti i količini korištenih sastojaka.

	 (kg)	 (min)	 (°C)	
 Krumpiri i povrće				
Pomfrit, tanki, smrznuto	0.3 - 0.7	9 - 16	180	Protresite košaru
Pomfrit, debeli, smrznuto	0.3 - 0.7	11 - 20	180	Protresite košaru
Pomfrit (8 x 8 mm)	0.3 - 0.8	10 - 16	180	Protresite košaru / Dodajte 1/2 žlice ulja
Krumpirići, svježi	0.3 - 0.8	18 - 22	180	Protresite košaru / Dodajte 1/2 žlice ulja
Kockice krumpira	0.3 - 0.75	12 - 18	180	Protresite košaru / Dodajte 1/2 žlice ulja
Punjeno povrće	0.1 - 0.4	10	170	-
Povrće	0.1 - 0.4	10	170	-
 Meso i perad				
Odrezak	0.1 - 0.5	8 - 12	200	-
Svinjeći kotleti	0.1 - 0.5	10 - 14	200	-
Hamburgeri	0.1 - 0.5	7 - 14	200	-
Kobasice u tijestu	0.1 - 0.5	13 - 15	200	-
Pileći bataci	0.1 - 0.5	18 - 22	180	-
Pileća prsa	0.1 - 0.5	10 - 15	185	-
Pile	0.9 - 1.2	40 - 50	180	-
 Grickalice				
Proletne rolice, smrznute	0.1 - 0.4	8 - 10	200	Protresite košaru
Pileći medaljoni, smrznuto	0.1 - 0.5	6 - 10	200	Protresite košaru

	 (kg)	 (min)	 (°C)	
Ribljí štapići, smrznuto	0.1 - 0.4	6 - 10	200	-
Panirani prutići od sira, smrznuti	0.1 - 0.4	8 - 10	180	-
 Pečenje				
Kolači	0.3	20 - 25	165	Koristite lim za pečenje
Quiche	0.4	20 - 22	185	Koristite lim za pečenje / posudu za pećnicu
Muffini	0.3	15 - 18	200	Koristite lim za pečenje

6. NAPOMENE O ČIŠĆENJU

	Sredstva za čišćenje i dodaci	Svakodnevna uporaba
	<p>Očistite pliticu i košaru spužvom namočenom u mlaku sapunicu.</p> <p>Plitica i košara sigurne su za pranje u perilici posuđa.</p> <p>Grijač očistite četkom za čišćenje.</p> <p>Vanjsku stranu uređaja očistite mekom krpom.</p>	<p>Prije čišćenja iskopčajte uređaj iz napajanja i pričekajte da se ohladi.</p> <p>Očistite uređaj nakon svake upotrebe.</p>

7. ŠTO UČINITI AKO...

Problem	Provjerite...
Ne možete uključiti uređaj ili rukovati njime.	<ul style="list-style-type: none"> • Uređaj je pravilno priključen na električno napajanje. • Vrijeme pripreme jela je postavljeno.
Ne možete umetnuti pliticu u uređaj.	<ul style="list-style-type: none"> • Košara nije napunjena do maksimalnog kapaciteta. • Košara je pravilno postavljena. Mora kliknuti kada je stavite u pliticu.
Iz uređaja izlazi bijeli dim.	<ul style="list-style-type: none"> • Hrana koju pripremate nije masna. • Plitica i košara su čiste.

8. TEHNIČKI PODACI

8.1 Tehnički podaci

Napon	220 - 240 V
Frekvencija	50 - 60 Hz

1. CELKOVÝ POHLED

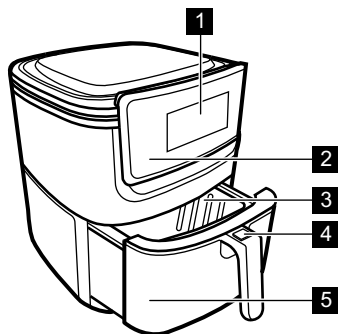

- 1** Displej
- 2** Ovládací panel
- 3** Koš
- 4** Bezpečnostní pojistka s ochranným krytem
- 5** Pekáč

2. OVLÁDACÍ PANEL

2.1 Ovládací panel

Seznamte se se základními symboly na ovládacím panelu a displeji.

ZAP/VYP	Nahoru	Dolů	Teplota	Trvání

Podporované vaření - příprava s automatickým nastavením času a teploty.

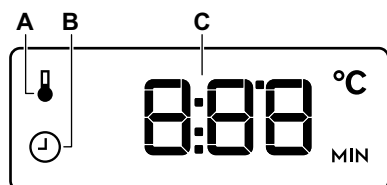

Ryby	Steak	Kuřecí stehna	Kuře
Zelenina	Hranolky	Mini pizza	Muffin

2.2 Displej



- A.** Nastavení teploty
- B.** Nastavení času
- C.** Čas / teplota

3. PŘED PRVNÍM POUŽITÍM

	Odstraňte veškerý obalový materiál, štítky a ochrannou fólii.
	Koš a pekáč umyjte teplou vodou s mycím prostředkem a pomocí měkkého hadříku. Vnitřek i vnějšek spotřebiče osušte pomocí hadříku.
	Při prvním použití může produkt uvolňovat netoxický zápach, který okamžitě zmizí. To nemá vliv na použití.

4. DENNÍ POUŽÍVÁNÍ

4.1 Jak používat: pekáč a koš

Spotřebič položte na stabilní povrch.

1. Vyjměte pekáč a položte ho na stabilní povrch.
2. Sejměte ochranný kryt na bezpečnostní pojistce.
3. Stiskněte bezpečnostní pojistku a vyjměte koš.

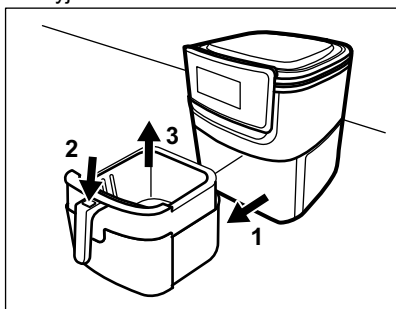

4. Vložte potraviny do koše až po maximální úroveň. Maximální kapacita koše je 2 kg.

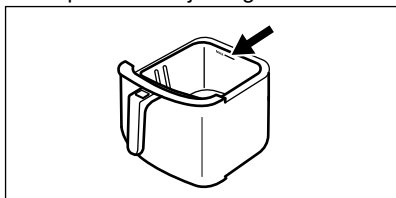









4.2 Příprava pokrmů

Vložte potraviny do koše. Zapojte spotřebič do zásuvky.

1.  – stiskněte a podržte.

2. Zvolte pokrm z nabídky Asistované vaření:

Symbol	Nastavení
	140 °C 15 min
	200 °C 10 min
	180 °C 20 min
	180 °C 45 min
	170 °C 15 min
	180 °C 15 min
	180 °C 10 min
	180 °C 15 min

3. Stiskněte: .
Po dokončení vaření pracuje několik sekund chladičí ventilátor a poté zazní zvukový signál.

Během přípravy můžete změnit nastavení a vypnout spotřebič:

- Program změňte stisknutím symbolu pokrmu.
- \wedge , \vee – stisknutím upravíte nastavení času nebo teploty.







-  – stisknutím a podržením na několik sekund vypnete spotřebič.

Odpojte spotřebič ze zásuvky a vyčkejte, dokud nevychladne. Umyjte pekáč a koš.

5. TIPY PRO PŘÍPRAVU

Teploty a časy přípravy v tabulkách jsou pouze orientační. Závisí na receptu, kvalitě a množství použitých přísad.

	 (kg)	 (min)	 (°C)	
 Brambory a zelenina				
Hranolky, tenké, zmrazené	0.3 - 0.7	9 - 16	180	Zatřeste košem
Hranolky, silné, zmrazené	0.3 - 0.7	11 - 20	180	Zatřeste košem
Hranolky (8 x 8 mm)	0.3 - 0.8	10 - 16	180	Zatřeste košem / přidejte půl lžice oleje
Americké brambory, čerstvé	0.3 - 0.8	18 - 22	180	Zatřeste košem / přidejte půl lžice oleje
Brambory na kostky	0.3 - 0.75	12 - 18	180	Zatřeste košem / přidejte půl lžice oleje
Plněná zelenina	0.1 - 0.4	10	170	-
Zelenina	0.1 - 0.4	10	170	-
 Maso a drůbež				
Steak	0.1 - 0.5	8 - 12	200	-
Vepřové kotlety	0.1 - 0.5	10 - 14	200	-
Hamburgery	0.1 - 0.5	7 - 14	200	-
Klobásy v těstíčku	0.1 - 0.5	13 - 15	200	-
Kuřecí stehna	0.1 - 0.5	18 - 22	180	-
Kuřecí prsa	0.1 - 0.5	10 - 15	185	-
Kuře	0.9 - 1.2	40 - 50	180	-
 Snack				
Jarní závitky, mražené	0.1 - 0.4	8 - 10	200	Zatřeste košem

	 (kg)	 (min)	 (°C)	
Kuřecí nugety, zmrazené	0.1 - 0.5	6 - 10	200	Zatřeste košem
Rybí prsty, zmrazené	0.1 - 0.4	6 - 10	200	-
Sýrový snack se strouhankou, zmrazený	0.1 - 0.4	8 - 10	180	-
 Pečení moučných jídel				
Koláče	0.3	20 - 25	165	Použijte formu na pečení
Slaný koláč	0.4	20 - 22	185	Použijte formu na pečení / nádobu do trouby
Muffin	0.3	15 - 18	200	Použijte formu na pečení

6. POZNÁMKY K ČIŠTĚNÍ

	Čistící prostředky a příslušenství	Každodenní použití
	<p>Pekáč a koš umyjte měkkou houbičkou namočenou v roztoku teplé vody a mycího prostředku.</p> <p>Pekáč a koš lze bezpečně mýt v myčce nádobí.</p> <p>Topné těleso očistěte kartáčkem.</p> <p>Vnější část spotřebiče očistěte měkkým hadříkem.</p>	<p>Před čištěním spotřebič odpojte od síťového napájení a vyčkejte, dokud nevychladne.</p> <p>Spotřebič čistěte po každém použití.</p>

7. CO DĚLAT, KDYŽ...

Problém	Zkontrolujte, zda...
Spotřebič nelze zapnout ani používat.	<ul style="list-style-type: none"> Spotřebič je správně zapojený do elektrické sítě. Je nastavený čas přípravy.
Nelze zasunout pekáč do spotřebiče.	<ul style="list-style-type: none"> Koš není naplněn nad maximální úroveň. Koš je umístěn správně. Když ho vložíte do pekáče, musí zaklapnout.
Ze spotřebiče nevychází bílý kouř.	<ul style="list-style-type: none"> Připravené pokrmy nejsou mastné. Pekáč a koš jsou čisté.

8. TECHNICKÉ ÚDAJE

8.1 Technické údaje

Napětí	220 - 240 V
Frekvence	50 - 60 Hz

1. OVERSIGT OVER APPARATET

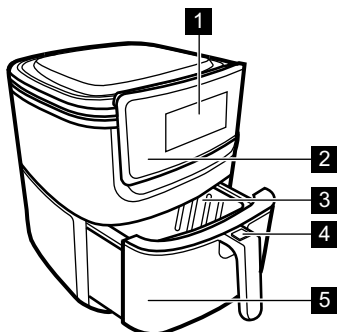

- 1** Display
- 2** Kontrolpanel
- 3** Kurv
- 4** Sikkerhedslås med beskyttelsesdæksel
- 5** Form

2. BETJENINGSPANEL

2.1 Kontrolpanel

Gør dig bekendt med de grundlæggende symboler på kontrolpanelet og displayet.



Temperatur



Varighed

Hjælp til tilberedning - tilbered med automatiske tids- og temperaturindstillinger.



Fisk



Bøf



Kyllingelår



Kylling



Grøntsager



Pommes Frites



Mini pizza



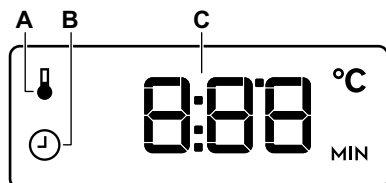

Muffins

2.2 Display



- A.** Temperaturindstilling
- B.** Tidsindstilling
- C.** Tid / temperatur

3. FØR BRUG FØRSTE GANG

	Fjern al emballagen, mærkningen og den beskyttende film.
	Rengør kurven og formen med varmt vand, opvaskemiddel og en blød klud. Tør apparatets inder- og yderside med en klud.
	Ved første brug kan produktet afgive giftfri lugt, som straks forsvinder. Dette påvirker ikke brugen.

4. DAGLIG BRUG

4.1 Anvendelse: form og kurv

Placer apparatet på en stabil overflade.

1. Fjern formen og placer den på en stabil overflade.
2. Fjern beskyttelsesdækslet på sikkerhedslåsen.
3. Tryk på sikkerhedslåsen for at fjerne kurven.

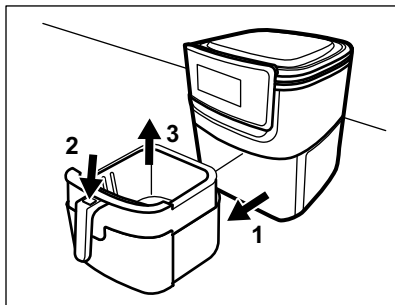



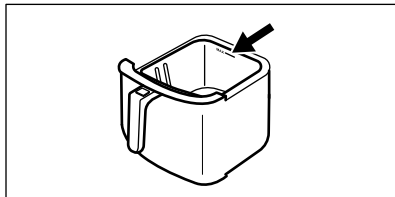





4. Læg maden i kurven op til det maksimale niveau. Kurvens maksimale kapacitet er 2 kg.



4.2 Madlavning

Læg maden i kurven. Sæt stikket til apparatet i stikkontakten.



1.  – tryk og hold.
2. Vælg retten fra "Hjælp til tilberedning":

Symbol	Indstilling
	140 °C 15 min
	200 °C 10 min
	180 °C 20 min
	180 °C 45 min
	170 °C 15 min
	180 °C 15 min
	180 °C 10 min
	180 °C 15 min

3. Tryk på: .
Når tilberedningen er færdig, vil køleblanderen køre et par sekunder, før signalet lyder.

Du kan ændre indstillingerne og slukke for apparatet under tilberedning:









- Tryk på madsymbolet for at ændre programmet.







-  ,  – tryk for at justere tid- eller temperaturindstillinger.
-  – tryk og hold nede i nogle få sekunder for at slukke for apparatet.

Træk apparatets stik ud, og vent, til det er koldt. Rengør formen og kurven.

5. TIPS TIL MADLAVNING

Tabellernes temperaturer og tilberedningstider er kun vejledende. De afhænger af opskrifterne samt af kvaliteten og mængden af de anvendte ingredienser.

	 (kg)	 (min.)	 (°C)	
 Kartofler og grøntsager				
Pommes frites, tynde, frossen	0.3 - 0.7	9 - 16	180	Ryst kurven
Pommes frites, tykke, frossen	0.3 - 0.7	11 - 20	180	Ryst kurven
Pommes Frites(8 x 8 mm)	0.3 - 0.8	10 - 16	180	Ryst kurven / Tilsæt 1/2 spsk. olie
Kartoffelbåde, friske	0.3 - 0.8	18 - 22	180	Ryst kurven / Tilsæt 1/2 spsk. olie
Kartoffeltern	0.3 - 0.75	12 - 18	180	Ryst kurven / Tilsæt 1/2 spsk. olie
Fyldte grøntsager	0.1 - 0.4	10	170	-
Grøntsager	0.1 - 0.4	10	170	-
 Kød og fjerkræ				
Bøf	0.1 - 0.5	8 - 12	200	-
Svinekotelet	0.1 - 0.5	10 - 14	200	-
Hamburger	0.1 - 0.5	7- 14	200	-
Pølsehorn	0.1 - 0.5	13 - 15	200	-
Kyllingelår	0.1 - 0.5	18 - 22	180	-
Kyllingebryst	0.1 - 0.5	10 - 15	185	-
Kylling	0.9 - 1.2	40 - 50	180	-
 Snacks				
Forårsruller, frosne	0.1 - 0.4	8 - 10	200	Ryst kurven
Kyllingenuggets, frosen	0.1 - 0.5	6 - 10	200	Ryst kurven

	 (kg)	 (min.)	 (°C)	
Fiskepinde, frosne	0.1 - 0.4	6 - 10	200	-
Panerede ostesnacks, frosne	0.1 - 0.4	8 - 10	180	-
 Bagning				
Kager	0.3	20 - 25	165	Brug en bradepande.
Quiche	0.4	20 - 22	185	Brug en bageform/ovnfad
Muffins	0.3	15 - 18	200	Brug en bradepande.

6. BEMÆRKNINGER OM RENGØRING

 <p>Rengøringsmidler og tilbehør Rengør formen og kurven med en blød svamp med varmt vand og opvaskemiddel. Formen og kurven kan kommes i opvaskemaskine. Rengør varmelegemet med en rengøringsbørste. Aftør apparatets yderside med en blød klud.</p>	<p>Hverdagsbrug Træk apparatets stik ud, og vent til det er koldt, inden rengøring. Rengør altid apparatet efter brug.</p>
--	---

7. HVIS NOGET GÅR GALT

Problem	Kontroller, at ...
Apparatet kan ikke tændes eller betjenes.	<ul style="list-style-type: none"> Apparatet er sluttet korrekt til en strømforsyning. Tilberedningstiden er indstillet.
Du kan ikke skubbe formen ind i apparatet.	<ul style="list-style-type: none"> Kurven er ikke fyldt op over dens maksimale kapacitet. Kurven er placeret korrekt. Den skal klikke, når du placerer den i formen.
Der kommer hvid røg ud af apparatet.	<ul style="list-style-type: none"> Den mad, du tilbereder, er ikke fedtet. Formen og kurven er rene.

8. TEKNISKE DATA

8.1 Tekniske data

Spænding	220 - 240 V
Hyppighed	50 - 60 Hz

1. GENERAL OVERVIEW

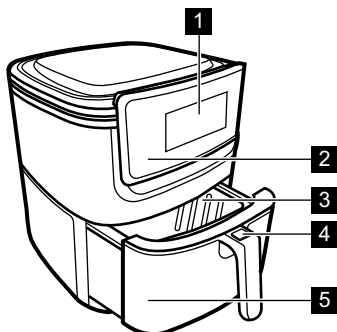

- 1** Display
- 2** Control panel
- 3** Basket
- 4** Safety lock with protection cover
- 5** Pan

2. CONTROL PANEL

2.1 Control panel

Familiarize yourself with the basic icons on the control panel and on the display.



ON / OFF



Up



Down



Temperature



Duration

Assisted Cooking - cook with automatic time and temperature settings.



Fish



Steak



Chicken drumsticks



Chicken



Vegetables



French fries



Mini pizza



Muffins

2.2 Display

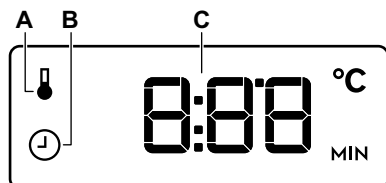

- A.** Temperature setting
- B.** Time setting
- C.** Time / temperature

3. BEFORE FIRST USE



Remove all the packaging, labelling and protective film.



Clean the basket and the pan with warm water, washing-up liquid and a soft cloth. Dry inside and outside of the appliance with a cloth.



At the first use, the product may release non-toxic odour, which disappears immediately. This does not affect the usage.

4. DAILY USE

4.1 How to use: pan and basket

Place the appliance on the stable surface.

1. Remove the pan and place it on a stable surface.
2. Remove the protection cover on the safety lock.
3. Press the safety lock to remove the basket.

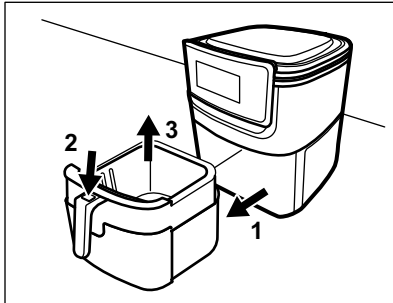

4. Put the food into the basket up to the maximum level. The maximum capacity of the basket is 2 kg.

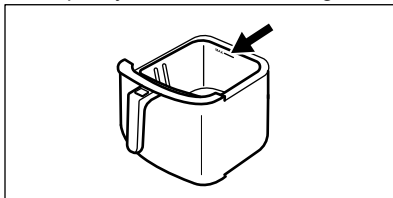

4.2 How to cook

Put the food into the basket. Plug in the appliance.

1. - press and hold.
2. Select the dish from Assisted cooking:

Symbol	Setting
	140°C 15 min
	200°C 10 min
	180°C 20 min
	180°C 45 min
	170°C 15 min
	180°C 15 min
	180°C 10 min
	180°C 15 min

3. Press: .

When the cooking ends, the cooling fan works for a few seconds, then the signal sounds.

You can change the settings and turn off the appliance during cooking:









- Press the food symbol to change the programme.
- \wedge , \vee - press to adjust time or temperature settings.







-  - press and hold for a few seconds to turn off the appliance.

Unplug the appliance and wait until it is cold. Clean the pan and the basket.

5. COOKING HINTS

The temperature and cooking times in the tables are guidelines only. They depend on the recipes and the quality and quantity of the ingredients used.

	 (kg)	 (min)	 (°C)	
 Potatoes and vegetables				
French fries, thin, frozen	0.3 - 0.7	9 - 16	180	Shake the basket
French fries, thick, frozen	0.3 - 0.7	11 - 20	180	Shake the basket
French fries (8 x 8 mm)	0.3 - 0.8	10 - 16	180	Shake the basket / Add 1/2 tablespoon of oil
Potato wedges, fresh	0.3 - 0.8	18 - 22	180	Shake the basket / Add 1/2 tablespoon of oil
Potato cubes	0.3 - 0.75	12 - 18	180	Shake the basket / Add 1/2 tablespoon of oil
Stuffed vegetables	0.1 - 0.4	10	170	-
Vegetables	0.1 - 0.4	10	170	-
 Meat and poultry				
Steak	0.1 - 0.5	8 - 12	200	-
Pork chops	0.1 - 0.5	10 - 14	200	-
Hamburger	0.1 - 0.5	7- 14	200	-
Sausage rolls	0.1 - 0.5	13 - 15	200	-
Chicken drumsticks	0.1 - 0.5	18 - 22	180	-
Chicken breast	0.1 - 0.5	10 - 15	185	-
Chicken	0.9 - 1.2	40 - 50	180	-
 Snacks				
Spring rolls, frozen	0.1 - 0.4	8 - 10	200	Shake the basket

	 (kg)	 (min)	 (°C)	
Chicken nuggets, frozen	0.1 - 0.5	6 - 10	200	Shake the basket
Fish fingers, frozen	0.1 - 0.4	6 - 10	200	-
Bread crumbed cheese snacks, frozen	0.1 - 0.4	8 - 10	180	-
 Baking				
Cakes	0.3	20 - 25	165	Use a baking tin
Quiche	0.4	20 - 22	185	Use a baking tin / oven dish
Muffins	0.3	15 - 18	200	Use a baking tin

6. NOTES ON CLEANING

	<p>Cleaning agents and accessories</p> <p>Clean the pan and the basket with a soft sponge with warm water and a washing-up liquid.</p> <p>The pan and the basket are dishwasher-safe.</p> <p>Clean the heating element with a cleaning brush.</p> <p>Clean the outside of the appliance with a soft cloth.</p>	<p>Everyday use</p> <p>Before cleaning unplug the appliance and wait until it is cold.</p> <p>Clean the appliance after each use.</p>
---	---	--

7. WHAT TO DO IF...

Problem	Check if...
You cannot activate or operate the appliance.	<ul style="list-style-type: none"> The appliance is correctly connected to an electrical supply. The cooking time is set.
You cannot slide the pan into the appliance.	<ul style="list-style-type: none"> The basket is not filled over its maximum capacity. The basket is placed correctly. It has to click when you place it in the pan.
White smoke comes out of the appliance.	<ul style="list-style-type: none"> The food you prepare is not greasy. The pan and the basket are clean.

8. TECHNICAL DATA

8.1 Technical data

Voltage	220 - 240 V
Frequency	50 - 60 Hz



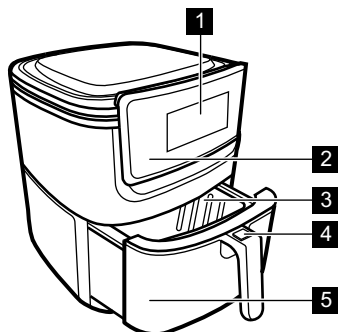



1. ÜLEVAADE



- 1** Ekraan
- 2** Juhtpaneel
- 3** Korv
- 4** Turvalukk koos kaitsekattega
- 5** Pann

2. JUHTPANEEL

2.1 Juhtpaneel

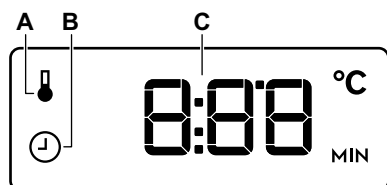

Jätke meelde juhtpaneelil ja ekraanil olevad põhiikoonid.				
				
SISSE/VÄLJA	Üles	Alla	Temperatuur	Kestus
Juhendatud küpsetamine – küpsetage automaatsete aja- ja temperatuuriseadetega.				
				
Kala	Steik	Kanakoivad	Kanaliha	
				
Köögiviljad	Friikartulid	Minipitsa	Muffinid	

2.2 Ekraan



- A.** Temperatuuriseade
- B.** Ajaseade
- C.** Aeg / temperatuur

3. ENNE ESIMEST KASUTAMIST

	Eemaldage kogu pakend, sildid ja kaitsekile.
	Puhastage korvi ja panni sooja vee, nõudepesuvahendi ja pehme lapiga. Kuivatage seade seest ja väljast lapiga.
	Pärast esmakordset kasutamist võib toode eraldada mittetoksilist lõhna, mis haihtub kohe. See ei mõjuta kasutust.

4. IGAPÄEVANE KASUTAMINE

4.1 Kuidas kasutada: panni ja korvi

Asetage seade kindlale alusele.

1. Eemaldage pann ja pange see kindlale alusele.
2. Eemaldage turvaluku kaitsekate.
3. Korvi eemaldamiseks vajutage turvalukku.

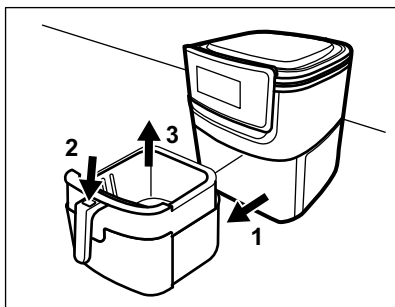

4. Pange toit korvi kuni maksimaalse tähiseni. Korvi maksimaalne mahutavus on 2 kg.

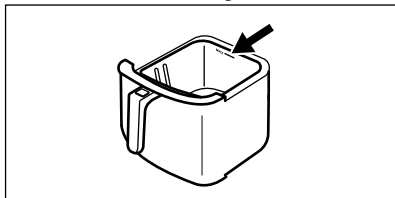







4.2 Kuidas küpsetada

Pange toit korvi. Pange toitepistik seinakontakti.

1.  – vajutage ja hoidke all.

2. Valige toit jaotisest Juhendatud küpsetamine:

Sümbol	Sätte
	140°C 15 min
	200°C 10 min
	180°C 20 min
	180°C 45 min
	170°C 15 min
	180°C 15 min
	180°C 10 min
	180°C 15 min

3. Vajutage nuppu: .
Küpsetamise lõppedes töötab jahutusventilaator paar sekundit, seejärel kostab helisignaali.

Küpsetamise ajal võite seadeid muuta ja seadme välja lülitada:









- Vajutage toidu sümbolit, et muuta programmi.
- \wedge , \vee – vajutage, et muuta aega või temperatuuriseadeid.







-  – vajutage ja hoidke paar sekundit, et seade välja lülitada.

Eemaldage seade vooluvõrgust ja laske maha jahtuda. Puhastage pann ja korv.

5. NÕUANDED VALMISTAMISEKS

Tabelites esitatud temperatuurid ja küpsetusajad on ainult soovituslikud. Täpsemalt sõltuvad need retseptist ning kasutatava tooraine kvaliteedist ja kogustest.

	 (kg)	 (min)	 (°C)	
 Kartulid ja juurviljad				
Friikartulid, õhukesed, külmutatud	0.3 - 0.7	9 - 16	180	Raputage korvi
Friikartulid, paksud, külmutatud	0.3 - 0.7	11 - 20	180	Raputage korvi
Friikartulid (8 x 8 mm)	0.3 - 0.8	10 - 16	180	Raputage korvi / lisage 1/2 spl õli
Kartuliviilud, värsked	0.3 - 0.8	18 - 22	180	Raputage korvi / lisage 1/2 spl õli
Kartulikuubikud	0.3 - 0.75	12 - 18	180	Raputage korvi / lisage 1/2 spl õli
Täidetud köögiviljad	0.1 - 0.4	10	170	-
Köögiviljad	0.1 - 0.4	10	170	-
 Liha ja linnuliha				
Steik	0.1 - 0.5	8 - 12	200	-
Seakarbonaad	0.1 - 0.5	10 - 14	200	-
Hamburger	0.1 - 0.5	7 - 14	200	-
Viineripirukad	0.1 - 0.5	13 - 15	200	-
Kanakoivad	0.1 - 0.5	18 - 22	180	-
Kanarind	0.1 - 0.5	10 - 15	185	-
Kanaliha	0.9 - 1.2	40 - 50	180	-
 Suupisted				
Kevadrullid, külmutatud	0.1 - 0.4	8 - 10	200	Raputage korvi

	 (kg)	 (min)	 (°C)	
Kananagitsad, külmutatud	0.1 - 0.5	6 - 10	200	Raputage korvi
Kalapulgad, külmutatud	0.1 - 0.4	6 - 10	200	-
Paneeritud juustupalad, külmutatud	0.1 - 0.4	8 - 10	180	-
 Küpsetamine				
Koogid	0.3	20 - 25	165	Kasutage küpsetusvormi
Quiche	0.4	20 - 22	185	Kasutage küpsetusvormi / ahjunõud
Muffinid	0.3	15 - 18	200	Kasutage küpsetusvormi

6. JUHISED PUHASTAMISEKS

	Puhastusvahendid ja tarvikud	Igapäevane kasutamine
	<p>Puhastage panni ja korvi pehme käsna või lapiga ning sooja vee ja nõudepesuvahendi lahusega.</p> <p>Panni ja korvi võib pesta nõudepesumasinas. Kütteelementi tuleb puhastada puhastusharjaga.</p> <p>Puhastage seadme välispinda pehme lapiga.</p>	<p>Enne puhastamist eemaldage seade vooluvõrgust ja laske maha jahtuda.</p> <p>Puhastage seadet pärast igakordset kasutamist.</p>

7. MIDA TEHA, KUI...

Probleem	Kontrollige, kas:
Seadet ei saa käivitada või kasutada.	<ul style="list-style-type: none"> Seade on elektrivõrku õigesti ühendatud. Küpsetusaeg on valitud.
Panni ei õnnestu seadmesse libistada.	<ul style="list-style-type: none"> Korv ei ole täidetud üle maksimaalse tähise. Korv on paigutatud õigesti. Panni sisse asetamisel peab kostma klõpsatus.
Seadmele tuleb valget suitsu.	<ul style="list-style-type: none"> Valmistatav toit ei ole rasvane. Pann ja korv on puhtad.

8. TEHNILISED ANDMED

8.1 Tehnilised andmed

Pinge	220 - 240 V
-------	-------------

Sagedus

50 - 60 Hz

1. LAITTEEN OSAT

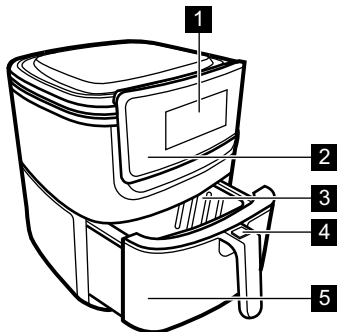

- 1 Näyttö
- 2 Käyttöpaneeli
- 3 Kori
- 4 Turvalukitus suojakannella
- 5 Pannu

2. KÄYTTÖPANEELI

2.1 Käyttöpaneeli

Tutustu käyttöpaneelin ja näytön peruskuvakkeisiin.

PÄÄLLE/POIS	Ylös	Alas	Lämpötila	Kesto-aika

Avustava ruoanvalmistus - valmista ruokaa automaattisilla aika- ja lämpötila-asetuksilla.

Kala	Pihvit	Broilerin koivet	Kana
Vihannekset	Ranskalaiset perunat	Minipizza	Muffinssit

2.2 Näyttö

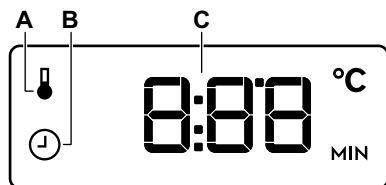

- A. Lämpötila-asetus
- B. Ajan asettaminen
- C. Aika/lämpötila

3. ENNEN ENSIKÄYTTÖÄ



Poista kaikki pakkausmateriaalit, merkit ja suojakalvot.



Pese kori ja pannu lämpimällä vedellä käyttäen käsitiskiainetta ja pehmeää liinaa. Kuivaa laitteen sisä- ja ulkopuoli liinalla.



Ensikäytön yhteydessä tuotteesta voi lähteä myrkytöntä hajua, joka häviää välittömästi. Tämä ei vaikuta tuotteen käyttöön.

4. PÄIVITTÄINEN KÄYTTÖ

4.1 Käyttöohjeet: pannu ja kori

Aseta laite vakaan alustan päälle.

- Poista pannu ja aseta se vakaalle alustalle.
- Poista turvalukituksen suojakansi.
- Paina kori painamalla turvalukitusta.

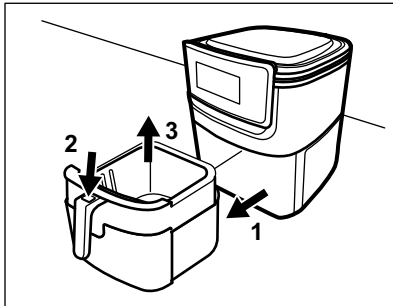

- Lisää elintarvikkeet koriin korkeintaan maksimitasoon saakka. Korin maksimitilavuus on 2 kg.

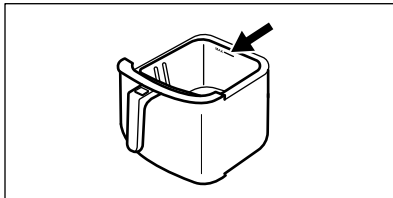

4.2 Ruoan valmistaminen

Aseta ruoka-ainekset koriin. Kytke laite sähköverkkoon.

- ⓪ – paina ja pidä painettuna.
- Valitse ruokalaji Avustava ruoanvalmistus -valikosta:



Symboli	Asetus
	140 °C 15 min
	200 °C 10 min
	180 °C 20 min
	180 °C 45 min
	170 °C 15 min
	180 °C 15 min
	180 °C 10 min
	180 °C 15 min

3. Paina: ⓪.

Kun ruoanlaitto on päättynyt, jäähtytävä puhallin toimii vielä muutaman sekunnin, jonka jälkeen kuuluu äänimerkki.

Voit muuttaa asetuksia ja kytkeä laitteen pois päältä ruoanlaiton aikana:









- Vaihda ohjelmaa painamalla ruoan symbolia.







-  ,  – säädä aikaa tai lämpötila-asetuksia painamalla.
-  – kytke laite pois päältä painamalla ja pitämällä alhaalla muutaman sekunnin ajan.

Irrota laite pistorasiasta ja odota, että se jäähtyy. Puhdista pannu ja kori.

5. RUOANLAITTOVINKIT

Taulukoissa mainitut lämpötilat ja paistoajat ovat ainoastaan suuntaa antavia. Lämpötila ja paistoaika riippuvat reseptistä sekä käytettyjen aineiden laadusta ja määrästä.

	 (kg)	 (min)	 (°C)	
 Perunat ja vihannekset				
Ranskalaiset, ohuet, pakasteet	0,3 - 0,7	9 - 16	180	Ravista koria
Ranskalaiset, paksut, pakasteet	0,3 - 0,7	11 - 20	180	Ravista koria
Ranskalaiset perunat (8 x 8 mm)	0,3 - 0,8	10 - 16	180	Ravista koria / lisää 1/2 rkl öljyä
Lohkoperunat, tuoreet	0,3 - 0,8	18 - 22	180	Ravista koria / lisää 1/2 rkl öljyä
Perunakuutiot	0,3 - 0,75	12 - 18	180	Ravista koria / lisää 1/2 rkl öljyä
Täytetyt vihannekset	0,1 - 0,4	10	170	-
Vihannekset	0,1 - 0,4	10	170	-
 Liha ja linnunliha				
Pihvit	0,1 - 0,5	8 - 12	200	-
Porsaankylyykset	0,1 - 0,5	10 - 14	200	-
Jauhelihapihvi	0,1 - 0,5	7 - 14	200	-
Makkarakullat	0,1 - 0,5	13 - 15	200	-
Broilerin koivet	0,1 - 0,5	18 - 22	180	-
Kanan rintafilee	0,1 - 0,5	10 - 15	185	-
Kana	0,9 - 1,2	40 - 50	180	-
 Välipalat				
Kevätkääryleet, pakastetut	0,1 - 0,4	8 - 10	200	Ravista koria

	 (kg)	 (min)	 (°C)	
Kananugetit, pakasteet	0,1 - 0,5	6 - 10	200	Ravista koria
Kalapuikot, pakasteet	0,1 - 0,4	6 - 10	200	-
Paneroidut juustovälipalat, pakaste	0,1 - 0,4	8 - 10	180	-
 Leivonnaisten paistaminen				
Kakut	0,3	20 - 25	165	Käytä uunivuokaa
Piirakka	0,4	20 - 22	185	Käytä uunivuokaa
Muffinsit	0,3	15 - 18	200	Käytä uunivuokaa

6. PUHDISTUKSEEN LIITTYVIÄ HUOMAUTUKSIA

	Puhdistusaineet ja lisävarusteet	Jokapäiväinen käyttö
	<p>Puhdista pannu ja kori lämpimällä vedellä ja käsitiskiaineella käyttäen pehmeää sientä. Pannu ja kori voidaan pestä astianpesukoneessa.</p> <p>Puhdista lämpövastus harjalla.</p> <p>Puhdista laitteen ulkopuoli pehmeällä liinalla.</p>	<p>Irrota laite pistorasiasta ennen sen puhdistamista ja odota, että se jäähtyy.</p> <p>Puhdista keittotaso jokaisen käytön jälkeen.</p>

7. KÄYTTÖHÄIRIÖT

Ongelma	Tarkista, että
Laite ei kytkeydy toimintaan eikä sitä voida käyttää.	<ul style="list-style-type: none"> Laite on kytketty virheettömästi sähköverkkoon. Kypsennysaika on asetettu.
Pannua ei voida liu'uttaa laitteeseen.	<ul style="list-style-type: none"> Koria ei ole täytetty liian täyteen. Kori on asetettu oikein. Se napsahtaa, kun se asetetaan pannuun.
Laitteesta tulee vaaleaa savua.	<ul style="list-style-type: none"> Valmistettava ruoka ei ole rasvaista. Pannu ja kori ovat puhtaita.

8. TEKNISET TIEDOT

8.1 Tekniset tiedot

Jännite	220 - 240 V
Taajuus	50 - 60 Hz

1. PRÉSENTATION GÉNÉRALE

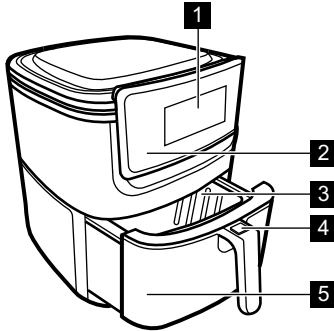

- 1** Affichage
- 2** Bandeau de commande
- 3** Panier
- 4** Verrouillage de sécurité avec couvercle de protection
- 5** Plat

2. BANDEAU DE COMMANDE

2.1 Bandeau de commande

Familiarisez-vous avec les symboles de base du bandeau de commande et de l'affichage :

MARCHE / ARRÊT	Haut	Bas	Température	Durée

Cuisson assistée - faites cuire avec les réglages automatiques de durée et de température.

Poisson	Steak	Pilons de poulet	Poulet
Légumes	Frites	Mini pizza	Muffins

2.2 Affichage

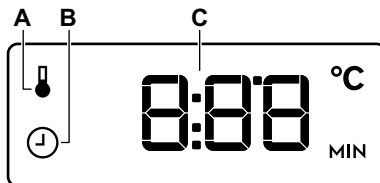

- A.** Réglage de température
- B.** Réglage de l'heure
- C.** Durée / Température

3. AVANT LA PREMIÈRE UTILISATION



Retirez les emballages, les étiquettes et les films de protection.



Nettoyez le panier et le plat avec de l'eau chaude, du liquide vaisselle et un chiffon doux.

Séchez l'intérieur et l'extérieur de l'appareil avec un chiffon.



Lors de la première utilisation, le produit peut dégager une odeur non toxique, qui disparaît immédiatement. Cela n'affecte pas l'utilisation.

4. UTILISATION QUOTIDIENNE

4.1 Comment utiliser : plat et panier

Placez l'appareil sur une surface stable.

1. Sortez le plat et placez-le sur une surface stable.
2. Retirez le couvercle de protection sur le verrouillage de sécurité.
3. Appuyez sur le verrouillage de sécurité pour retirer le panier.

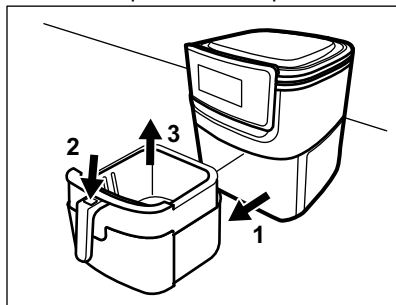

4. Placez les aliments dans le panier jusqu'au niveau maximum. Le panier a une capacité maximale de 2 kg.

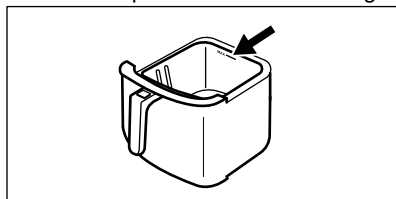

4.2 Comment cuire

Placez les aliments dans le panier. Branchez l'appareil.

1. - Maintenez la touche.

2. Sélectionnez le plat dans Cuisson assistée :

Symbole	Réglage
	140 °C 15 min
	200 °C 10 min
	180 °C 20 min
	180 °C 45 min
	170 °C 15 min
	180 °C 15 min
	180 °C 10 min
	180 °C 15 min

3. Appuyez sur : .

Lorsque la cuisson se termine, le ventilateur de refroidissement est activé pendant quelques secondes, puis le signal sonore est déclenché.

Vous pouvez modifier les réglages et mettre à l'arrêt l'appareil pendant la cuisson :









- Appuyez sur le symbole de l'aliment pour changer le programme.
- \wedge , \vee - appuyez pour ajuster les réglages de durée ou de température.







-  - appuyez et maintenez enfoncé pendant quelques secondes pour mettre à l'arrêt l'appareil.

Débranchez l'appareil et attendez qu'il soit froid. Nettoyez le plat et le panier.

5. CONSEILS DE CUISSON

Les températures et temps de cuisson se trouvant dans les tableaux ne sont indiqués qu'à titre indicatif. Ils varient en fonction des recettes ainsi que de la qualité et de la quantité des ingrédients utilisés.

	 (kg)	 (min)	 (°C)	
 Pommes de terre et légumes				
Frites, fines, surgelé	0,3 - 0,7	9 - 16	180	Secouez le panier
Frites, épaisses, surgelé	0,3 - 0,7	11 - 20	180	Secouez le panier
Frites (8 x 8 mm)	0,3 - 0,8	10 - 16	180	Secouez le panier / Ajoutez 1/2 cuillères à soupe d'huile
Quartiers de pommes de terre, frais	0,3 - 0,8	18 - 22	180	Secouez le panier / Ajoutez 1/2 cuillères à soupe d'huile
Cubes de pommes de terre	0,3 - 0,75	12 - 18	180	Secouez le panier / Ajoutez 1/2 cuillères à soupe d'huile
Légumes farcis	0,1 - 0,4	10	170	-
Légumes	0,1 - 0,4	10	170	-
 Viande et volaille				
Steak	0,1 - 0,5	8 - 12	200	-
Côtelettes de porc	0,1 - 0,5	10 - 14	200	-
Steak haché	0,1 - 0,5	7 - 14	200	-
Roulés aux saucisses	0,1 - 0,5	13 - 15	200	-
Pilons de poulet	0,1 - 0,5	18 - 22	180	-
Blanc de poulet	0,1 - 0,5	10 - 15	185	-
Poulet	0,9 - 1,2	40 - 50	180	-
 En-cas				
Rouleaux de printemps, surgelés	0,1 - 0,4	8 - 10	200	Secouez le panier

	 (kg)	 (min)	 (°C)	
Nuggets de poulet, surgelé	0,1 - 0,5	6 - 10	200	Secouez le panier
Bâtonnets de poisson, surgelé	0,1 - 0,4	6 - 10	200	-
En-cas au fromage panés, surgelés	0,1 - 0,4	8 - 10	180	-
 Cuisson				
Gâteaux	0,3	20 - 25	165	Utilisez un moule à gâteaux.
Quiche	0,4	20 - 22	185	Utilisez un moule à gâteaux / plat allant au four
Muffins	0,3	15 - 18	200	Utilisez un moule à gâteaux.

6. REMARQUES CONCERNANT L'ENTRETIEN

	Produits de nettoyage et accessoires	Utilisation quotidienne
	<p>Nettoyez le plat et le panier avec à l'aide d'une éponge douce avec de l'eau chaude et du liquide vaisselle.</p> <p>Le plat et le panier peuvent passer au lave-vaisselle.</p> <p>Nettoyez l'élément chauffant avec une brosse de nettoyage.</p> <p>Nettoyez l'extérieur de l'appareil avec un chiffon doux.</p>	<p>Avant le nettoyage, débranchez l'appareil et attendez qu'il soit froid.</p> <p>Nettoyez l'appareil après chaque utilisation.</p>

7. QUE FAIRE SI...

Problème	Vérifiez si...
Vous ne pouvez pas mettre en fonctionnement l'appareil ni le faire fonctionner.	<ul style="list-style-type: none"> • L'appareil est correctement branché à la prise électrique. • La durée de cuisson est réglée
Vous ne pouvez pas faire coulisser le plat dans l'appareil.	<ul style="list-style-type: none"> • Le panier n'est pas rempli au-delà de sa capacité maximale. • Le panier est placé correctement. Il doit s'enclencher lorsque vous le placez dans le plat.
De la fumée blanche sort de l'appareil.	<ul style="list-style-type: none"> • Les aliments que vous préparez ne sont pas gras. • Le plat et le panier sont propres.

8. CARACTÉRISTIQUES TECHNIQUES

8.1 Caractéristiques techniques

Tension	220 - 240 V
Fréquence	50 - 60 Hz

1. GESAMTANSICHT

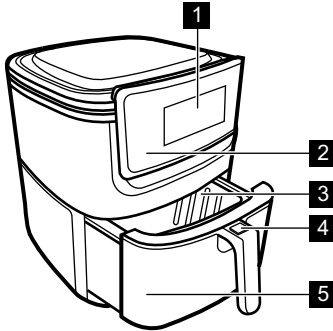

- 1** Display
- 2** Bedienfeld
- 3** Korb
- 4** Sicherheitsverriegelung mit Schutzabdeckung
- 5** Gar-Behälter

2. BEDIENFELD

2.1 Bedienfeld

Machen Sie sich mit den grundlegenden Symbolen auf dem Bedienfeld und auf dem Display vertraut.

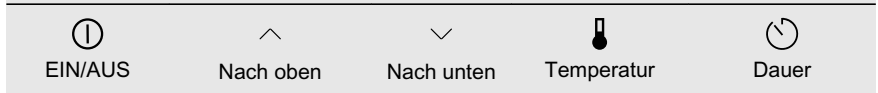

Koch-Assistent - Kochen mit automatischen Zeit- und Temperatureinstellungen.

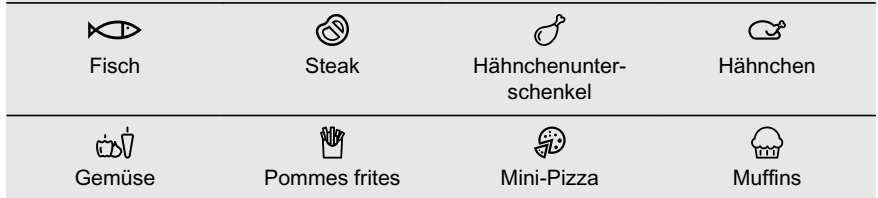

2.2 Display

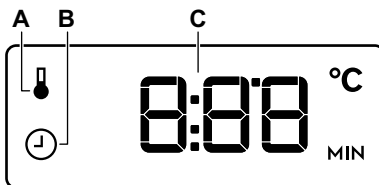

- A.** Temperatureinstellung
- B.** Zeiteinstellung
- C.** Zeit/Temperatur

3. VOR DER ERSTEN VERWENDUNG



Entfernen Sie die gesamte Verpackung, Kennzeichnung und Schutzfolie.



Feuchten Sie ein weiches Tuch mit warmem Wasser und etwas Spülmittel an und reinigen Sie damit den Korb und den Gar-Behälter. Trocknen Sie das Gerät innen und außen mit einem Tuch ab.



Bei der ersten Verwendung kann das Produkt unangenehmen Geruch freisetzen, der aber sofort verschwindet. Dies hat keine Auswirkung auf die Nutzung.

4. TÄGLICHER GEBRAUCH

4.1 Verwendung: Gar-Behälter und Korb

Stellen Sie das Gerät auf eine stabile Oberfläche.

1. Nehmen Sie den Gar-Behälter heraus und stellen Sie ihn auf eine stabile Oberfläche.
2. Entfernen Sie die Schutzabdeckung und die Sicherheitsverriegelung.
3. Drücken Sie auf die Sicherheitsverriegelung, um den Korb zu entfernen.

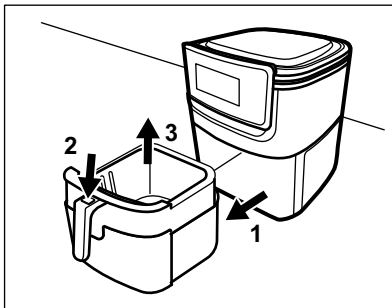



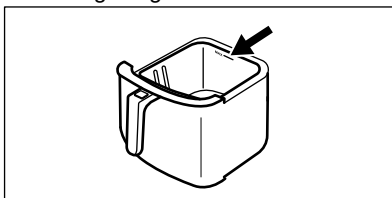





4. Füllen Sie die Zutaten in den Korb bis zur Höchstgrenze. Das maximale Fassungsvermögen des Korbs beträgt 2 kg.



4.2 So wird gekocht

Füllen Sie die Zutaten in den Korb. Schließen Sie das Gerät ans Stromnetz an.

1. Halten Sie  gedrückt.
2. Wählen Sie das Gericht im Koch-Assistenten:

Symbol	Einstellung
	140 °C 15 Min.
	200 °C 10 Min.
	180 °C 20 Min.
	180 °C 45 Min.
	170 °C 15 Min.
	180 °C 15 Min.
	180 °C 10 Min.
	180 °C 15 Min.

3. Drücken Sie: .

Nach Beendigung des Kochvorgangs läuft das Kühlgebläse einige Sekunden lang, dann ertönt das Signal.

Sie können die Einstellungen während des Garvorgangs ändern und das Gerät ausschalten:







- Drücken Sie auf das Speisensymbol, um das Programm zu ändern.
- Drücken Sie \wedge , \vee , um die Zeit- oder Temperatureinstellungen zu ändern.







- Halten Sie ⏸ einige Sekunden gedrückt, um das Gerät auszuschalten.

Ziehen Sie den Netzstecker und warten Sie, bis das Gerät kalt ist. Reinigen Sie den Gar-Behälter und den Korb.

5. GAREMPFEHLUNGEN

Die Temperaturen und Garzeiten in den Tabellen sind nur Richtwerte. Sie sind abhängig von den Rezepten, der Qualität und der Menge der verwendeten Zutaten.

	 (kg)	 (Min.)	 (°C)	
 Kartoffeln und Gemüse				
Pommes frites, dünn, gefroren	0.3 - 0.7	9 - 16	180	Schütteln Sie den Korb
Pommes frites, dick, gefroren	0.3 - 0.7	11 - 20	180	Schütteln Sie den Korb
Pommes frites (8 x 8 mm)	0.3 - 0.8	10 - 16	180	Schütteln Sie den Korb/Fügen Sie 1/2 Esslöffel Öl hinzu
Kartoffelspalten, frisch	0.3 - 0.8	18 - 22	180	Schütteln Sie den Korb/Fügen Sie 1/2 Esslöffel Öl hinzu
Kartoffelwürfel	0.3 - 0.75	12 - 18	180	Schütteln Sie den Korb/Fügen Sie 1/2 Esslöffel Öl hinzu
Gefülltes Gemüse	0.1 - 0.4	10	170	-
Gemüse	0.1 - 0.4	10	170	-
 Fleisch und Geflügel				
Steak	0.1 - 0.5	8 - 12	200	-
Schweinekoteletts	0.1 - 0.5	10 - 14	200	-
Hamburger	0.1 - 0.5	7 - 14	200	-
Würstchen im Teig	0.1 - 0.5	13 - 15	200	-
Hähnchenunterschenkel	0.1 - 0.5	18 - 22	180	-
Hähnchenbrust	0.1 - 0.5	10 - 15	185	-
Hähnchen	0.9 - 1.2	40 - 50	180	-

	 (kg)	 (Min.)	 (°C)	
 Snacks				
Frühlingsrollen, gefroren	0.1 - 0.4	8 - 10	200	Schütteln Sie den Korb
Chicken Nuggets, gefroren	0.1 - 0.5	6 - 10	200	Schütteln Sie den Korb
Fischstäbchen, gefroren	0.1 - 0.4	6 - 10	200	-
Panierte Käse-Snacks, gefroren	0.1 - 0.4	8 - 10	180	-
 Backen				
Kuchen	0.3	20 - 25	165	Verwenden Sie eine Backform
Quiche	0.4	20 - 22	185	Verwenden Sie eine Backform/Auflaufform
Muffins	0.3	15 - 18	200	Verwenden Sie eine Backform

6. HINWEISE ZUR REINIGUNG

	<p>Reinigungsmittel und Zubehör Feuchten Sie einen weichen Schwamm mit warmem Wasser und etwas Spülmittel an und reinigen Sie damit den Gar-Behälter und Korb. Der Gar-Behälter und der Korb sind spülmaschinenfest. Reinigen Sie das Heizelement mit einer Reinigungsbürste. Reinigen Sie die Außenseite des Geräts mit einem weichen Tuch.</p>	<p>Täglicher Gebrauch Ziehen Sie vor der Reinigung den Netzstecker und warten Sie, bis das Gerät kalt ist. Reinigen Sie das Gerät nach jedem Gebrauch.</p>
--	---	---

7. WAS TUN, WENN...

Störung	Prüfen Sie, ob...
Das Gerät kann nicht eingeschaltet oder bedient werden.	<ul style="list-style-type: none"> • Das Gerät ordnungsgemäß an die Spannungsversorgung angeschlossen ist. • Die Garzeit eingestellt ist.
Sie können den Gar-Behälter nicht in das Gerät schieben.	<ul style="list-style-type: none"> • Der Korb über sein maximales Fassungsvermögen gefüllt ist. • Der Korb richtig eingesetzt ist. Es muss klicken, wenn Sie ihn in den Gar-Behälter einsetzen.

Störung	Prüfen Sie, ob...
Weißer Rauch tritt aus dem Gerät aus.	<ul style="list-style-type: none">• Die von Ihnen zubereitete Speise fettig ist.• Der Gar-Behälter und der Korb sauber sind.

8. TECHNISCHE DATEN

8.1 Technische Daten

Spannung	220 - 240 V
Frequenz	50 - 60 Hz

1. ÁLTALÁNOS ÁTTEKINTÉS

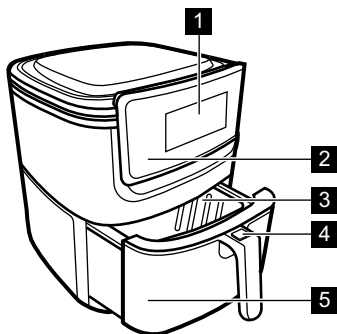

- 1 Kijelző
- 2 Kezelőpanel
- 3 Kosár
- 4 Biztonsági zár védőburkolattal
- 5 tepsí

2. KEZELŐPANEL

2.1 Kezelőpanel

Ismerkedjen meg a kezelőpanelen és a kijelzőn található alapvető ikonokkal.

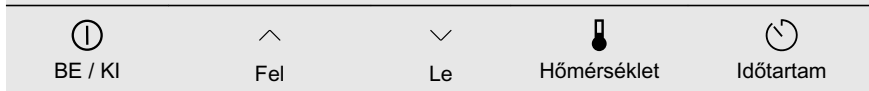

Előre programozott sütés - főzés automatikus idő- és hőmérséklet-beállításokkal.

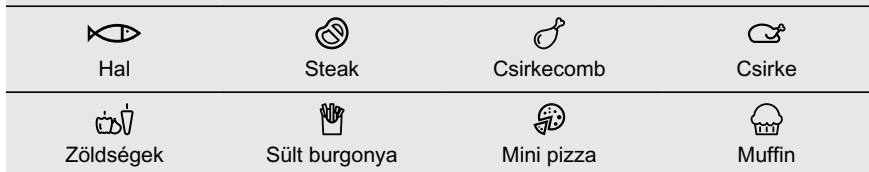

2.2 Kijelző

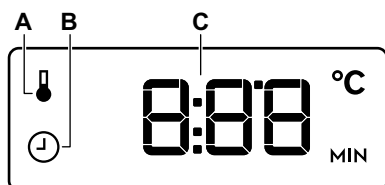

- A. Hőmérséklet-beállítás
- B. Időbeállítás
- C. Idő / hőmérséklet

3. AZ ELSŐ HASZNÁLAT ELŐTT



Távolítsa el az összes csomagolóanyagot, tájékoztató címkét és védőfóliát.



A kosarat és a tepsit tisztítószeres meleg vízzel megnedvesített puha ruhával tisztítsa meg.

A készülék belsejét és külsejét kendővel törölje szárazra.



Első használat alkalmával a termék szagot bocsáthat ki magából, amely nem mérgező és azonnal elillan. Ez nem befolyásolja a használatot.

4. NAPI HASZNÁLAT

4.1 Hogyan használja: tepsí és kosár

Helyezze a készüléket egy stabil felületre.

1. Távolítsa el a tepsit, és tegye egy stabil felületre.
2. Távolítsa el a védőburkolatot a biztonsági zárról.
3. A kosár eltávolításához nyomja meg a biztonsági zárat.

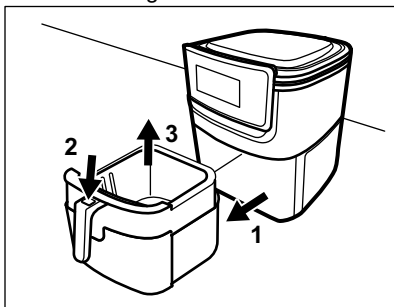

4. Töltse fel a kosarat az élelmiszerrel a maximális szintig. A kosár maximális úrtartalma 2 kg.

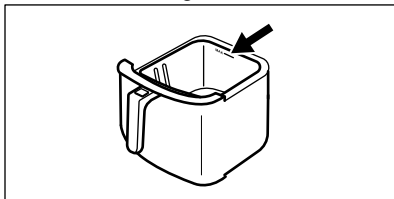

4.2 Tanácsok a főzéshez

Tegye az ételt a kosárba. Csatlakoztassa a készüléket a konnektorhoz.

1. - nyomja meg és tartsa megnyomva.
2. Válassza ki az ételt az Előre programozott sütés menüből:

Szimbólum	Beállítás
	140 °C 15 perc
	200 °C 10 perc
	180 °C 20 perc
	180 °C 45 perc
	170 °C 15 perc
	180 °C 15 perc
	180 °C 10 perc
	180 °C 15 perc

3. Nyomja meg: .
Amint a főzés véget ér, a hűtőventilátor néhány másodpercre bekapcsol, majd hangjelzés lesz hallható.

Főzés közben módosíthatja a beállításokat, és kikapcsolhatja a készüléket:









- A program módosításához nyomja meg az étel szimbólumot.
- \wedge , \vee - nyomja meg az idő vagy a hőmérséklet-beállítás módosításához.







-  - a készülék kikapcsolásához tartsa nyomva néhány másodpercig.

Húzza ki a készülék dugaszát a konnektorból, és várja meg, hogy a készülék lehűljön. Tisztítsa meg a tepsit és a kosarat.

5. FŐZÉSI TANÁCSOK

A táblázatban szereplő hőmérsékleti értékek és sütési időtartamok csak tájékoztatóként szolgálnak. A valós értékek a receptektől, a felhasznált összetevők minőségétől és mennyiségétől függenek.

	 (kg)	 (perc)	 (°C)	
 Burgonya és zöldségek				
Sült burgonya, vékony, fagyasztott	0.3 - 0.7	9 - 16	180	Rázza meg a kosarat
Sült burgonya, vastag, fagyasztott	0.3 - 0.7	11 - 20	180	Rázza meg a kosarat
Sült burgonya (8 x 8 mm)	0.3 - 0.8	10 - 16	180	Rázza meg a kosarat / Kenje meg 1/2 evőkanál étolajjal
Hasábburgonya, friss	0.3 - 0.8	18 - 22	180	Rázza meg a kosarat / Kenje meg 1/2 evőkanál étolajjal
Burgonyakockák	0.3 - 0.75	12 - 18	180	Rázza meg a kosarat / Kenje meg 1/2 evőkanál étolajjal
Töltött zöldség	0.1 - 0.4	10	170	-
Zöldségek	0.1 - 0.4	10	170	-
 Hús és szárnyas				
Steak	0.1 - 0.5	8 - 12	200	-
Sertésborda	0.1 - 0.5	10 - 14	200	-
Hamburger	0.1 - 0.5	7- 14	200	-
Kolbászos tekercs	0.1 - 0.5	13 - 15	200	-
Csirkecomb	0.1 - 0.5	18 - 22	180	-
Csirkemell	0.1 - 0.5	10 - 15	185	-
Csirke	0.9 - 1.2	40 - 50	180	-
 Aprósütemény				

	 (kg)	 (perc)	 (°C)	
Tavaszi tekercs, fagyaszott	0.1 - 0.4	8 - 10	200	Rázza meg a kosarat
Csirkefalatok, fagyaszott	0.1 - 0.5	6 - 10	200	Rázza meg a kosarat
Halrudacsok, fagyaszott	0.1 - 0.4	6 - 10	200	-
Kenyérmorzsa, sajtos aprósütemény, fagyaszott	0.1 - 0.4	8 - 10	180	-
 Tésztasütés				
Sütemények	0.3	20 - 25	165	Használjon sütőformát
Quiche	0.4	20 - 22	185	Használjon sütőformát / hőálló edényt
Muffin	0.3	15 - 18	200	Használjon sütőformát

6. TISZTÍTÁSSAL KAPCSOLATOS MEGJEGYZÉSEK

	Tisztítószeres és tartozékok	Napi használat
	<p>A tepsit és a kosarat tisztítószeres meleg vízzel megnedvesített puha szivaccsal törölje le. A tepsit és a kosár mosogatógépben tisztítható. A fűtőelemet kefével tisztítsa. A készülék külsejét puha ruhával törölje le.</p>	<p>Tisztítás előtt húzza ki a készülék dugaszát a konnektorból, és várja meg, hogy a készülék lehűljön. Minden használat után tisztítsa meg a készüléket.</p>

7. MI A TEENDŐ, HA ...

Jelenség	Ellenőrizze a következőket:
Nem lehet elindítani vagy üzemeltetni a készüléket.	<ul style="list-style-type: none"> A készüléket megfelelően csatlakoztatta az elektromos hálózathoz. A sütési idő be van állítva.
Nem lehet becsúsztatni a tepsit a készülékbe.	<ul style="list-style-type: none"> A kosár nincs a maximális szint fölé töltve. A kosár megfelelően van behelyezve. Kattanó hangot kell hallani a tepsibe való behelyezéskor.
Fehér füst jön ki a készülékből.	<ul style="list-style-type: none"> A készülő étel nem zsíros. A tepsit és a kosár tiszta.

8. MŰSZAKI ADATOK

8.1 Műszaki adatok

Feszültség	220 - 240 V
Frekvencia	50 - 60 Hz



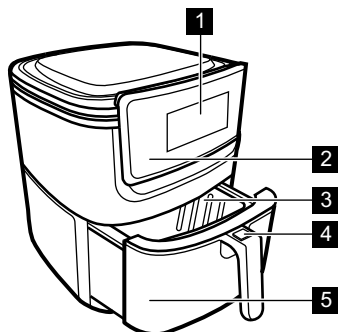



1. PANORAMICA



- 1** Display
- 2** Pannello di controllo
- 3** Cestello
- 4** Blocco di sicurezza con coperchio di protezione
- 5** Leccarda

2. PANNELLO DEI COMANDI

2.1 Pannello di controllo

Acquisire familiarità con le icone di base sul pannello di controllo e sul display.				
				
ACCESO / SPENTO	Su	Giù	Temperatura	Durata
Cottura guidata - cuocere con impostazioni automatiche di tempo e temperatura.				
				
Pesce	Bistecca	Cosce di pollo	Pollo	
				
Verdure	Patatine fritte	Mini pizza	Muffin	

2.2 Display

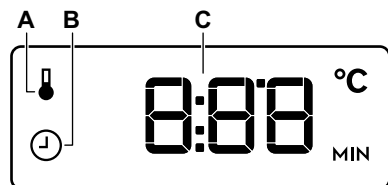

- A.** Impostazione temperatura
- B.** Impostazione del tempo
- C.** Tempo / temperatura

3. PRIMA DI UTILIZZARE L'APPARECCHIATURA PER LA PRIMA VOLTA



Togliere tutto l'imballaggio, le etichette e la pellicola protettiva.



Pulire cestello e padella con acqua calda, un po' di liquido detergente e un panno soffice.

Asciugare all'interno e all'esterno dell'apparecchiatura con un panno.



Al primo utilizzo, il prodotto potrebbe rilasciare odore non tossico, che scompare immediatamente. Ciò non influisce sull'uso.

4. UTILIZZO QUOTIDIANO

4.1 Come si usa: padella e cestello

Appoggiare l'apparecchiatura su una superficie stabile.

1. Sollevare la pentola e posizionarla su una superficie stabile.
2. Rimuovere il coperchio di protezione sul blocco di sicurezza.
3. Abbassare il blocco di sicurezza per estrarre il cestello.

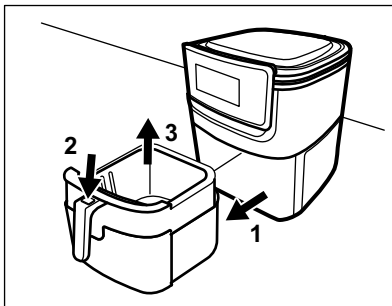

4. Mettere il cibo nel cestello fino al livello massimo. La capacità massima del cestello è 2 kg.

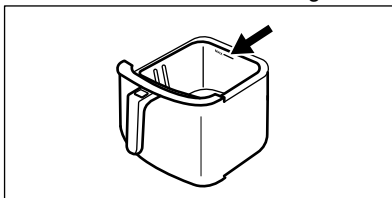

4.2 Come cucinare

Collocare il cibo nel cestello. Inserire la spina dell'apparecchiatura nella presa di corrente.

1. - Tenere premuto.
2. Selezionare il piatto da cottura guidata:

Simbolo	Impostazione
	140 °C 15 min
	200 °C 10 min
	180 °C 20 min
	180 °C 45 min
	170 °C 15 min
	180 °C 15 min
	180 °C 10 min



	180 °C 15 min
--	------------------

3. Premere: .

Al termine della cottura, la ventola di raffreddamento si attiva per alcuni secondi, quindi viene emesso un segnale acustico.

È possibile modificare le impostazioni e spegnere l'apparecchiatura durante la cottura:







- Premere il simbolo del cibo per modificare il programma.







- ,  - premere per regolare le impostazioni di tempo o temperatura.
-  - tenere premuto per alcuni secondi per spegnere l'apparecchiatura.

Scollegare la spina dell'apparecchiatura dalla corrente e attendere che l'apparecchiatura sia fredda. Pulire la padella e il cestello.

5. CONSIGLI DI CUCINA

La temperatura ed i tempi di cottura specificati nelle tabella sono valori indicativi. Possono variare in base alle ricette, alla qualità e alla quantità degli ingredienti utilizzati.

	 (kg)	 (min)	 (°C)	
 Patate e verdure				
Patatine fritte sottili, surgelato	0,3 - 0,7	9 - 16	180	Agitare il cestello
Patatine fritte tagliate spesse, surgelato	0,3 - 0,7	11 - 20	180	Agitare il cestello
Patatine fritte (8 x 8 mm)	0,3 - 0,8	10 - 16	180	Agitare il cestello / Aggiungere 1/2 cucchiaino d'olio
Spicchi di patate, freschi	0,3 - 0,8	18 - 22	180	Agitare il cestello / Aggiungere 1/2 cucchiaino d'olio
Patate a dadini	0,3 - 0,75	12 - 18	180	Agitare il cestello / Aggiungere 1/2 cucchiaino d'olio
Verdure farcite	0,1 - 0,4	10	170	-
Verdure	0,1 - 0,4	10	170	-
 Carne e pollame				
Bistecca	0,1 - 0,5	8 - 12	200	-
Bracioline di maiale	0,1 - 0,5	10 - 14	200	-
Hamburger	0,1 - 0,5	7 - 14	200	-
Involtoni di salsiccia	0,1 - 0,5	13 - 15	200	-
Cosce di pollo	0,1 - 0,5	18 - 22	180	-

	 (kg)	 (min)	 (°C)	
Petto di pollo	0,1 - 0,5	10 - 15	185	-
Pollo	0,9 - 1,2	40 - 50	180	-
 Snack				
Involtini primavera, surgelati	0,1 - 0,4	8 - 10	200	Agitare il cestello
Nugget di pollo, surgelato	0,1 - 0,5	6 - 10	200	Agitare il cestello
Bastoncini di pesce, surgelato	0,1 - 0,4	6 - 10	200	-
Spuntini al formaggio panati, congelati	0,1 - 0,4	8 - 10	180	-
 Panificare				
Torte	0,3	20 - 25	165	Usare una leccarda
Quiche	0,4	20 - 22	185	Usare una leccarda / teglia da forno
Muffin	0,3	15 - 18	200	Usare una leccarda

6. NOTE SULLA PULIZIA

	Detergenti e accessori	Uso quotidiano
	<p>Pulire la padella e il cestello con una spugna morbida inumidita con acqua tiepida saponata.</p> <p>La padella e il cestello sono lavabili in lavastoviglie.</p> <p>Pulire l'elemento riscaldante con uno spazzolino.</p> <p>Pulire il lato esterno dell'apparecchiatura con un panno inumidito.</p>	<p>Prima della pulizia, spegnere l'apparecchiatura e attendere che sia fredda.</p> <p>Pulire l'apparecchiatura dopo ogni utilizzo.</p>

7. COSA FARE SE...

Problema	Controllare se...
Non è possibile attivare l'apparecchiatura o metterla in funzione.	<ul style="list-style-type: none"> L'apparecchiatura è stata collegata in modo corretto all'alimentazione di rete. Il tempo di cottura è impostato.

Problema	Controllare se...
Non è possibile far scivolare la padella nell'apparecchiatura.	<ul style="list-style-type: none"> • Il cestello non viene riempito oltre la sua capacità massima. • Il cestello è posizionato correttamente. Deve scattare quando lo si mette nella padella.
Fumo bianco esce dall'apparecchio.	<ul style="list-style-type: none"> • Il cibo preparato non è grasso. • La padella e il cestello sono puliti.

8. DATI TECNICI

8.1 Dati tecnici

Tensione	220 - 240 V
Frequenza	50 - 60 Hz

1. VISPĀRĒJS PĀRSKATS

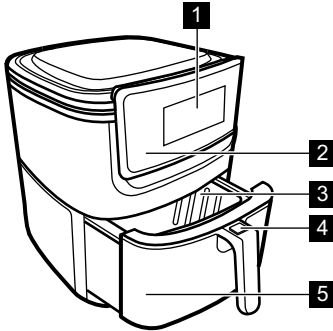

- 1** Displejs
- 2** Vadības panelis
- 3** Grozs
- 4** Drošības slēdzene ar aizsardzības pārsegu
- 5** Panna

2. VADĪBAS PANELIS

2.1 Vadības panelis

Iepazīstieties ar galvenajām ikonām vadības panelī un uz displeja.

IESLĒGT / IZ-SLĒGT	Uz augšu	Uz leju	Temperatūra	Darb. laiks

Gatavošanas palīgs - gatavošana ar automātiskajiem laika un temperatūras iestatījumiem.

Zivs	Steiks	Vistu stilbiņi	Vista
Dārzeni	Kartupeļi frī	Mini pica	Mufini

2.2 Displejs

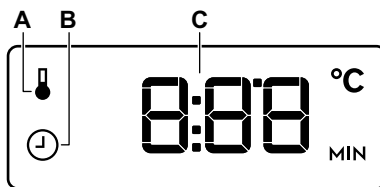

- A.** Temperatūras iestatījums
- B.** Laika iestatījums
- C.** Laiks / temperatūra

3. PIRMS PIRMĀS LIETOŠANAS



Noņemiet visus iesaiņojuma materiālus, uzlīmes un aizsargplēvi.



Nomazgājiet grozu un pannu ar karstu ūdeni, trauku mazgāšanas līdzekli un mikroviļņu drānu.

Nosusiniet ierīces iekšpusi un ārpusi ar drānu.



Lietojot pirmoreiz, produkts var izdalīt netoksisku smaržu, kura nekavējoties izzūd. Tas neietekmē lietošanu.

4. IZMANTOŠANA IKDIENĀ

4.1 Izmantošana: panna un grozs

Novietojiet ierīci uz stabilas virsmas.

1. Noņemiet pannu un novietojiet to uz stabilas virsmas.
2. Noņemiet aizsardzības pārsegu no drošības slēdzenes.
3. Nospiediet drošības slēdzeni, lai noņemtu grozu.

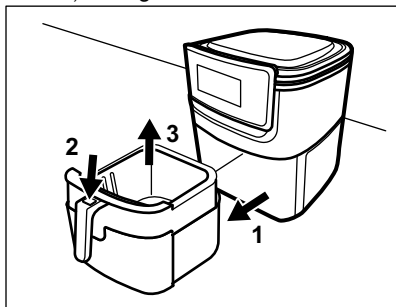

4. Ievietojiet produktus grozā līdz maksimālajam līmenim. Groza maksimālā ietilpība ir 2 kg.

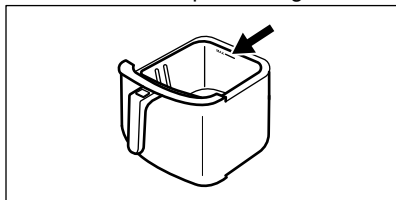

4.2 Gatavošana

Ievietojiet produktus grozā. Pieslēdziet ierīces kontaktspraudni kontaktligzdai.

1. — turiet nospiestu.

2. Atlasiet ēdienu no Gatavošanas palīga:

Simbols	Iestatījums:
	140 °C 15 min
	200 °C 10 min
	180 °C 20 min
	180 °C 45 min
	170 °C 15 min
	180 °C 15 min
	180 °C 10 min
	180 °C 15 min

3. Nospiediet . Beidzoties gatavošanas laikam, dzesēšanas ventilators turpina darboties pāris minūtes un pēc tam atskan skaņas signāls.

Jūs varat mainīt iestatījumus un izslēgt ierīci gatavošanas laikā.









- Nospiediet ēdiena simbolu, lai mainītu programmu.
- \wedge , \vee — nospiediet, lai regulētu laiku vai temperatūras iestatījumus.







-  — turiet nospiestu pāris sekunžu garumā, lai izslēgtu ierīci.

Atvienojiet ierīci no elektrotīkla un uzgaidiet, līdz tā atdziest. Nofīriet pannu un grozu.

5. GATAVOŠANAS PADOMI

Tabulās uzrādītā temperatūra un cepšanas laiki ir ir tikai orientējoši. Tie atkarīgi no receptēm un izmantoto sastāvdaļu kvalitātes un daudzuma.

	 (kg)	 (min.)	 (°C)	
 Kartupeļi un dārzeņi				
Kartupeļi frī, smalki, sal- dēti	0,3 - 0,7	9 - 16	180	Sakratiet grozu
Kartupeļi frī, biezi, sal- dēti	0,3 - 0,7	11 - 20	180	Sakratiet grozu
Kartupeļi frī (8 x 8 mm)	0,3 - 0,8	10 - 16	180	Sakratiet grozu / pievienojiet 1/2 ēdamkaroti eļļas
Kartupeļu daiviņas, svaigas	0,3 - 0,8	18 - 22	180	Sakratiet grozu / pievienojiet 1/2 ēdamkaroti eļļas
Kubiņos sagriezti kartu- peļi	0,3 - 0,75	12 - 18	180	Sakratiet grozu / pievienojiet 1/2 ēdamkaroti eļļas
Pildīti dārzeņi	0,1 - 0,4	10	170	-
Dārzeņi	0,1 - 0,4	10	170	-
 Gaļa un putnu gaļa				
Steiks	0,1 - 0,5	8 - 12	200	-
Cūkgaļas karbonāde ar ribiņu	0,1 - 0,5	10 - 14	200	-
Hamburgers	0,1 - 0,5	7 - 14	200	-
Kārtainā mīklā ieceptas desiņas	0,1 - 0,5	13 - 15	200	-
Vistu stilbiņi	0,1 - 0,5	18 - 22	180	-
Cāļa krūtiņa	0,1 - 0,5	10 - 15	185	-
Vista	0,9 - 1,2	40 - 50	180	-
 Uzkodas				

	 (kg)	 (min.)	 (°C)	
Dārzenų ruletītes, saldētas	0,1 - 0,4	8 - 10	200	Sakratiet grozu
Vistas nageti, saldēti	0,1 - 0,5	6 - 10	200	Sakratiet grozu
Zivju pirkstiņi, saldēti	0,1 - 0,4	6 - 10	200	-
Siera uzkodas rīvmaizē, saldētas	0,1 - 0,4	8 - 10	180	-
 Konditorejas izstrādājumiem				
Kūkas	0,3	20 - 25	165	Izmantojiet cepšanas formu
Sāļais pīrāgs	0,4	20 - 22	185	Izmantojiet cepšanas formu/ cepeškrāsns trauku
Mufini	0,3	15 - 18	200	Izmantojiet cepšanas formu

6. PIEZĪMES PAR TĪRĪŠANU



Tīrīšanas līdzekļi un piederumi

Notīriet pannu un grozu ar siltā ūdenī un trauku mazgājamā līdzeklī izmērcētu mīkstu drāniņu.

Pannu un grozu drīkst mazgāt trauku mazgājamajā mašīnā.

Notīriet sildelementu ar tīrīšanas suku.

Notīriet ierīces ārpusi ar mīkstu drāniņu.

Lietošana ikdienā

Pirms tīrīšanas atvienojiet ierīci no elektrotīkla un pagaidiet, līdz tā atdziest.

Tīriet ierīci pēc katras lietošanas reizes.

7. KO DARĪT, JA ...

Problēma	Pārbaudiet, vai:
Ierīci nevar ieslēgt vai lietot.	<ul style="list-style-type: none"> Ierīce ir pareizi pievienota strāvas padevei. Ir iestatīts gatavošanas laiks.
Pannu nevar iebīdīt ierīcē.	<ul style="list-style-type: none"> Nav pārsniegta groza maksimālā ietilpība. Grozs ir novietots pareizi, lievietojot to pannā, ir jāatskan klikšķim.
No ierīces izdalās balti dūmi.	<ul style="list-style-type: none"> Jūsu gatavotais ēdiens nav taukains. Panna un grozs ir tīrs.

8. TEHNISKIE DATI

8.1 Tehniskie dati

Spriegums	220 – 240 V
Frekvence	50 - 60 Hz

1. BENDRA APŽVALGA

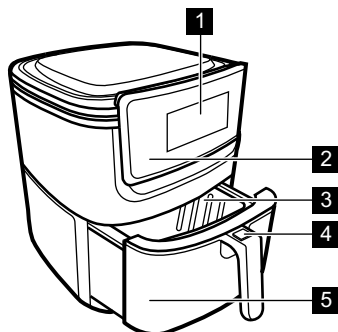





- 1** Valdymo skydelis
- 2** Valdymo skydelis
- 3** Krepšys
- 4** Saugos užraktas su apsauginiu dangteliu
- 5** Prikaistuvis









2. VALDYMO SKYDELIS

2.1 Valdymo skydelis

Susipažinkite su valdymo skydelio ir ekrano pagrindinėmis piktogramomis.

				
ĮJUNGIMAS / IŠJUNGIMAS	Aukštyn	Žemyn	Temperatūra	Trukmė

Kepimo vadovas - gaminkite, naudodami automatinės laiko ir temperatūros nuostatas.

			
Žuvis	Kepsnys	Viščiuko šlaunelės	Viščiukas
			
Daržovės	Gruzdintos bulvytės	Maža pica	Keksiukai

2.2 Valdymo skydelis

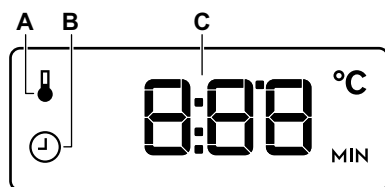

- A.** Temperatūros nustatymai
- B.** Laiko nuostata
- C.** Laikas / temperatūra

3. PRIEŠ NAUDODAMI PIRMĄ KARTĄ



Pašalinkite visas pakuotes, ženklinimo medžiagas ir apsauginę plėvelę.



Išplaukite krepšį ir prikaistuvį šiltu vandeniu ir plovimo skysčiu, tada išvalykite švelnia šluoste.

Šluoste nusausinkite prietaiso vidų ir išorę.



Pirmą kartą įjungtas prietaisas gali išskirti juntamas netoksines dujas, kurios iš karto išsisklaidys. Tai nedaro jokio poveikio prietaiso naudojimui.

4. KASDIENIS NAUDOJIMAS

4.1 Kaip naudoti: prikaistuvį ir krepšį

Pastatykite prietaisą ant stabilaus paviršiaus.

1. Nuimkite prikaistuvį ir padėkite jį ant stabilaus paviršiaus.
2. Nuimkite nuo saugos užrakto apsauginį dangtelį.
3. Norėdami ištraukti krepšį, paspauskite saugos užraktą.

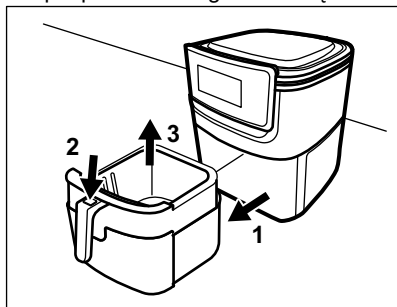

4. Sudėkite maistą į krepšį iki maksimalaus lygio. Maksimali krepšio talpa – 2 kg.

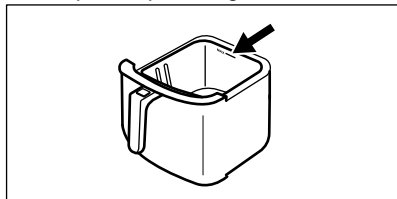

4.2 Kaip ruošti maistą

Sudėkite maistą į krepšį. Įjunkite prietaisą.

1. Palaikykite paspaudę ①.
2. Kepimo vadove pasirinkite patiekalą:

Simbolis	Nustatymai
	140 °C 15 min.
	200 °C 10 min.
	180 °C 20 min.
	180 °C 45 min.
	170 °C 15 min.
	180 °C 15 min.
	180 °C 10 min.
	180 °C 15 min.

3. Paspauskite ①.
Pasibaigus maisto ruošimo laikui, aušinimo ventiliatorius veiks kelias sekundes, tada pasigirs signalas.









Ruošdami maistą galite pakeisti nustatymus ir išjungti prietaisą:







- Jei norite pakeisti programą, paspauskite maisto simbolį.
- Jei norite pakeisti laiko arba temperatūros nustatymus, paspauskite \wedge arba \vee .

- Jei norite išjungti prietaisą, kelias sekundes palaikykite paspaustą ! . Išjunkite prietaisą ir palaukite, kol atvės. Išvalykite prikaistuvį ir krepšį.

5. MAISTO RUOŠIMO PATARIMAI

Lentelėse nurodyta temperatūra ir ruošimo laikas yra tik orientacinio pobūdžio. Jie priklauso nuo receptų, naudojamų produktų kokybės ir kiekio.

	 (kg)	 (min.)	 (°C)	
 Bulvės ir daržovės				
Gruzdintos bulvytės, plonai pjaustytos, šaldyti	0,3–0,7	9–16	180	Pakratykite krepšį
Gruzdintos bulvytės, stambiai pjaustytos, šaldyti	0,3–0,7	11–20	180	Pakratykite krepšį
Gruzdintos bulvytės (8 x 8 mm)	0,3–0,8	10–16	180	Pakratykite krepšį / įpilkite 1/2 valgomojo šaukšto aliejaus
Bulvių skiltelės, šviežios	0,3–0,8	18–22	180	Pakratykite krepšį / įpilkite 1/2 valgomojo šaukšto aliejaus
Bulvių kubeliai	0,3–0,75	12–18	180	Pakratykite krepšį / įpilkite 1/2 valgomojo šaukšto aliejaus
Įdarytos daržovės	0,1–0,4	10	170	–
Daržovės	0,1–0,4	10	170	–
 Mėsa ir paukštiena				
Kepsnys	0,1–0,5	8–12	200	–
Kiaulienos muštiniai	0,1–0,5	10–14	200	–
Mėsainis	0,1–0,5	7–14	200	–
Bandelės su dešra	0,1–0,5	13–15	200	–
Viščiuko šlaunelės	0,1–0,5	18–22	180	–
Vištienos krūtinėlė	0,1–0,5	10–15	185	–
Viščiukas	0,9–1,2	40–50	180	–
 Užkandžiai				

	 (kg)	 (min.)	 (°C)	
Pavasariniai ritinėliai, šaldyti	0,1–0,4	8–10	200	Pakratykite krepšį
Kepti vištienos gabalėliai, šaldyti	0,1–0,5	6–10	200	Pakratykite krepšį
Žuvų piršteliai, šaldyti	0,1–0,4	6–10	200	–
Sūrio užkandžiai, apvolioti duonos trupiniais, šaldyti	0,1–0,4	8–10	180	–
 Kepimas				
Pyragai	0,3	20–25	165	Naudokite kepimo skardą
Apkepas su įdaru	0,4	20–22	185	Naudokite kepimo skardą / orkaitėje kepti tinkamą indą
Keksiukai	0,3	15–18	200	Naudokite kepimo skardą

6. PASTABOS DĖL VALYMO

	Valymo priemonės ir priedai	Kasdienis naudojimas
	Nuvalykite prikaistuvį ir krepšį minkšta kempine su šiltu vandeniu ir plovimo skysčiu. Prikaistuvį ir krepšį galima plauti indaplovėje. Išvalykite kaitinamąjį elementą valymo šepečėliu. Nuvalykite prietaiso išorę minkšta šluoste.	Prieš valydami, išjunkite prietaisą ir palaukite, kol atvės. Prietaisą valykite po kiekvieno naudojimo.

7. KĄ DARYTI, JEIGU...

Problema	Patikrinkite, ar...
Prietaiso negalima įjungti arba valdyti.	<ul style="list-style-type: none"> • Prietaisas tinkamai prijungtas prie elektros tinklo lizdo. • Nustatyta gaminimo trukmė.
Negalite įstumti prikaistuvio į prietaisą.	<ul style="list-style-type: none"> • Krepšys nepripildytas daugiau nei maksimali talpa. • Krepšys tinkamai įdėtas. Turi spragtelėti, kai įdedate jį į prikaistuvį.
Iš prietaiso sklinda balti dūmai.	<ul style="list-style-type: none"> • Jūsų paruoštas maistas be riebalų. • Prikaistuvis ir krepšys yra švarūs.

8. TECHNINIAI DUOMENYS

8.1 Techniniai duomenys

Įtampa	220–240 V
Dažnis	50–60 Hz

1. GENERELL OVERSIKT

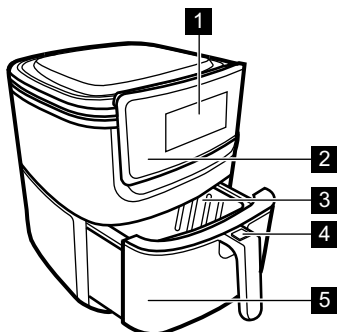

- 1** Display
- 2** Betjeningspanel
- 3** Kurv
- 4** Sikkerhetslås med beskyttelsesdeksel
- 5** Panne

2. BETJENINGSPANEL

2.1 Betjeningspanel

Bli kjent med de grunnleggende ikonene på betjeningspanelet og displayet.



Assistert matlaging - stek med automatiske tids- og temperaturinnstillinger.



2.2 Display

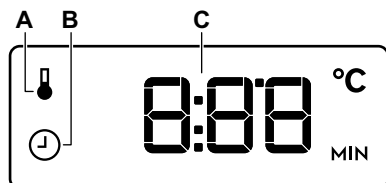

- A.** Temperaturinnstilling
- B.** Tidsinnstilling
- C.** Tid/temperatur

3. FØR FØRSTE BRUK

	Fjern all emballasje, merking og beskyttelsesfilm.
	Rengjør kurven og pannen med varmt vann, oppvaskmiddel og en myk klut. Tørk innsiden og utsiden av produktet med en klut.
	Første gang produktet brukes kan det slippe ut ikke-giftig lukt, som forsvinner umiddelbart. Dette påvirker ikke bruken.

4. DAGLIG BRUK

4.1 Slik bruker du: panne og kurv

Plasser produktet på den stabile overflaten.

1. Fjern pannen og plasser det på en stabil overflate.
2. Fjern beskyttelsesdekslet på sikkerhetslåsen.
3. Trykk på sikkerhetslåsen for å fjerne kurven.

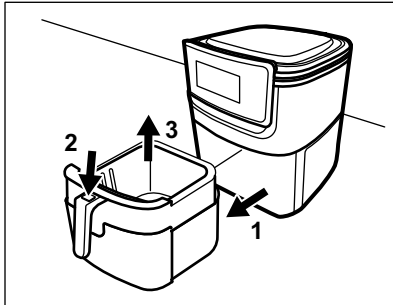



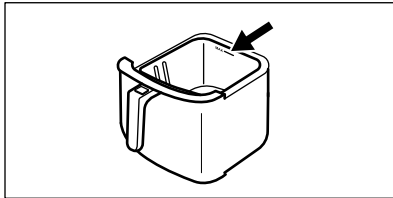





4. Legg maten i kurven opp til maksimalt nivå. Kurvens maksimale kapasitet er 2 kg.







4.2 Slik lager du mat

Sett maten i kurven. Koble apparatet til strømmen.

1.  – trykk og hold.
2. Velg retten fra Assistert matlaging:

Symbol	Innstilling
	140°C 15 min
	200°C 10 min
	180°C 20 min
	180°C 45 min
	170°C 15 min
	180°C 15 min
	180°C 10 min
	180°C 15 min









3. Trykk på: .
Når matlagingen er ferdig, går kjøleviften i noen sekunder, så høres lydsignalet.
Du kan endre innstillingene og slå av produktet under tilberedningen:
 - Trykk på matsymbolet for å endre programmet.







- ,  – trykk for å justere tids- eller temperaturinnstillinger.
-  – trykk og hold inne i et par sekunder for å slå av produktet.

Koble fra produktet og vent til det er kaldt. Rengjør pannen og kurven.

5. TIPS TIL TILBEREDNING

Temperaturer og steketider i tabellene er kun veiledende. De avhenger av oppskrift, samt mengde og kvalitet på ingrediensene som brukes.

	 (kg)	 (min.)	 (°C)	
 Poteter og grønnsaker				
Pommes frites, tynne, frossen	0,3 - 0,7	9 - 16	180	Rist kurven
Pommes frites, tykke, frossen	0,3 - 0,7	11 - 20	180	Rist kurven
Pommes Frites (8 x 8 mm)	0,3 - 0,8	10 - 16	180	Rist kurven / Tilsett 1/2 ss olje
Potetbåter, ferske	0,3 - 0,8	18 – 22	180	Rist kurven / Tilsett 1/2 ss olje
Poteterninger	0,3 - 0,75	12 – 18	180	Rist kurven / Tilsett 1/2 ss olje
Fylte grønnsaker	0,1 - 0,4	10	170	-
Grønnsaker	0,1 - 0,4	10	170	-
 Kjøtt og fjærkre				
Biff	0,1 - 0,5	8 - 12	200	-
Svinekoteletter	0,1 - 0,5	10 – 14	200	-
Hamburger	0,1 - 0,5	7 - 14	200	-
Pølsesuller	0,1 - 0,5	13 - 15	200	-
Kyllinglår	0,1 - 0,5	18 – 22	180	-
Kyllingbryst	0,1 - 0,5	10 - 15	185	-
Kylling	0,9 - 1,2	40 - 50	180	-
 Snacks				
Vårruller, frosne	0,1 - 0,4	8 - 10	200	Rist kurven
Kyllingnuggets, frossen	0,1 - 0,5	6 – 10	200	Rist kurven
Fiskepinner, frossen	0,1 - 0,4	6 – 10	200	-

	 (kg)	 (min.)	 (°C)	
Oste-/brødsnacks, frosne	0,1 - 0,4	8 - 10	180	-
 Steking av bakst				
Kaker	0,3	20 - 25	165	Bruk en bakeform
Quiche	0,4	20 - 22	185	Bruk en ildfast form / stekeplate
Muffins	0,3	15 - 18	200	Bruk en bakeform

6. MERKNADER OM RENGJØRING

	Rengjøringsmidler og tilbehør	Hverdagsbruk
	Rengjør pannen og kurven med en myk svamp med varmt vann og oppvaskmiddel. Pannen og kurven kan vaskes i oppvaskmaskin. Rengjør varmeelementet med en rengjøringsbørste. Rengjør utsiden av produktet med en myk klut.	Før du rengjør kobler du fra produktet og venter til det er kaldt. Rengjør produktet etter hver bruk.

7. HVA MÅ GJØRES, HVIS ...

Problem	Kontroller at ...
Du kan ikke slå på eller betjene produktet.	<ul style="list-style-type: none"> • Produktet er riktig koblet til strømforsyningen. • Tilberedningstiden er innstilt.
Du kan ikke skyve pannen inn i produktet.	<ul style="list-style-type: none"> • Kurven er ikke fylt over sin maksimale kapasitet. • Kurven er plassert riktig. Den må klikke når du legger den i pannen.
Hvit røyk kommer ut av produktet.	<ul style="list-style-type: none"> • Maten du tilbereder er ikke fet. • Pannen og kurven er rene.

8. TEKNISKE DATA

8.1 Tekniske data

Spenning	220 - 240 V
Frekvens	50 - 60 Hz

1. WIDOK URZĄDZENIA

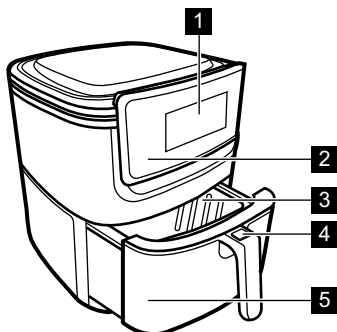





- 1 Wyświetlacz
- 2 Panel sterowania
- 3 Kosz
- 4 Blokada z osłoną zabezpieczającą
- 5 Blacha do pieczenia

2. PANEL STEROWANIA

2.1 Panel sterowania

Zapoznać się z podstawowymi symbolami na panelu sterowania i wyświetlaczu.

				
WŁĄCZONE/ WYŁĄCZONE	W górę	W dół	Temperatura	Czas

Gotowanie wspomagane – pieczenie z automatycznymi ustawieniami czasu i temperatury.

			
Ryby	Stek	Udka kurczaka	Kurczak
			
Warzywa	Frytki	Minipizza	Babeczki

2.2 Wyświetlacz

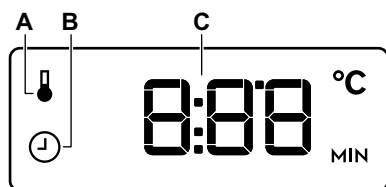

- A. Ustawienie temperatury
- B. Ustawienie czasu
- C. Czas/temperatura

3. PRZED PIERWSZYM UŻYCIEM



Usunąć wszystkie elementy opakowania, etykiety i folię ochronną.



Umyć kosz i pojemnik w ciepłej wodzie z płynem do mycia naczyń za pomocą miękkiej ściereczki.

Osuszyć urządzenie w środku i na zewnątrz za pomocą szmatki.



Podczas pierwszego użycia produkt może uwalniać nieprzyjemny zapach, który szybko ustąpi. Nie ma to wpływu na działanie urządzenia.

4. CODZIENNA EKSPLOATACJA

4.1 Obsługa urządzenia: pojemnik i kosz

Postawić urządzenie na stabilnej powierzchni.

- Wyjąć pojemnik i postawić go na stabilnej powierzchni.
- Zdjąć osłonę zabezpieczającą z blokady.
- Nacisnąć blokadę, aby wyjąć kosz.

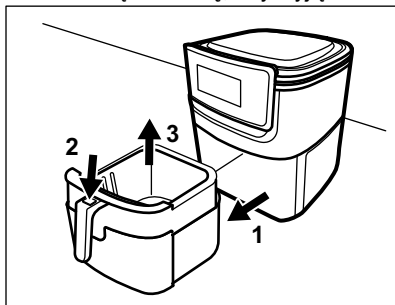

- Napełnić kosz składnikami do maksymalnego poziomu. Maksymalna ładowność kosza wynosi 2 kg.

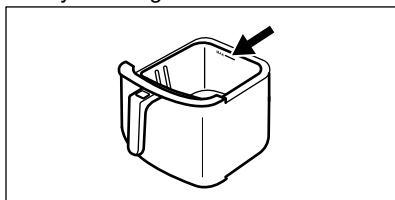

4.2 Sposób pieczenia

Umieścić składniki w koszu. Podłączyć urządzenie.

- nacisnąć i przytrzymać.
- Wybrać potrawę z menu Gotowanie wspomagane:

Symbol	Ustawienie
	140°C 15 min
	200°C 10 min
	180°C 20 min
	180°C 45 min
	170°C 15 min
	180°C 15 min
	180°C 10 min
	180°C 15 min

- Nacisnąć: .
Po zakończeniu gotowania wentylator chłodzący działa przez kilka sekund, po czym rozlega się sygnał.









Podczas pieczenia można zmienić ustawienia lub wyłączyć urządzenie.







- Nacisnąć symbol produktu, aby zmienić program.
- \wedge , \vee – nacisnąć, aby dostosować ustawienia czasu lub temperatury.
- $\text{\textcircled{1}}$ – nacisnąć i przytrzymać przez kilka sekund, aby wyłączyć urządzenie.

Odłączyć urządzenie od zasilania i poczekać, aż ostygnie. Wyczyścić pojemnik i kosz.

5. WSKAZÓWKI DOTYCZĄCE PIECZENIA

Temperatury i czasy pieczenia podane w tabelach mają wyłącznie charakter orientacyjny. Zależą one od przepisu, jakości oraz ilości użytych składników.

	 (kg)	 (min)	 (°C)	
 Ziemniaki i warzywa				
Frytki, cienkie, mrożone	0.3 - 0.7	9 - 16	180	Potrząsnąć koszem
Frytki, grube, mrożone	0.3 - 0.7	11 - 20	180	Potrząsnąć koszem
Frytki (8 x 8 mm)	0.3 - 0.8	10 - 16	180	Potrząsnąć koszem / Dodać 1/2 łyżki oleju
Ćwiartki ziemniaków, świeże	0.3 - 0.8	18 - 22	180	Potrząsnąć koszem / Dodać 1/2 łyżki oleju
Ziemniaki pokrojone w kostkę	0.3 - 0.75	12 - 18	180	Potrząsnąć koszem / Dodać 1/2 łyżki oleju
Nadziewane warzywa	0.1 - 0.4	10	170	-
Warzywa	0.1 - 0.4	10	170	-
 Mięso i drób				
Stek	0.1 - 0.5	8 - 12	200	-
Kotlety wieprzowe	0.1 - 0.5	10 - 14	200	-
Hamburger	0.1 - 0.5	7- 14	200	-
Kiełbaski zapiekane	0.1 - 0.5	13 - 15	200	-
Udka kurczaka	0.1 - 0.5	18 - 22	180	-
Pierś kurczaka	0.1 - 0.5	10 - 15	185	-
Kurczak	0.9 - 1.2	40 - 50	180	-
 Przekąski				
Sajgonki, mrożone	0.1 - 0.4	8 - 10	200	Potrząsnąć koszem

	 (kg)	 (min)	 (°C)	
Nuggety z kurczaka, mrożone	0.1 - 0.5	6 - 10	200	Potrząsnąć koszem
Paluszki rybne, mrożone	0.1 - 0.4	6 - 10	200	-
Przekąski serowe w panierce, mrożone	0.1 - 0.4	8 - 10	180	-
 Pieczenie ciast				
Ciasta	0.3	20 - 25	165	Użyć foremki do ciasta
Quiche	0.4	20 - 22	185	Użyć foremki do ciasta/naczynia żaroodpornego
Babeczki	0.3	15 - 18	200	Użyć foremki do ciasta

6. UWAGI DOTYCZĄCE CZYSZCZENIA

	Środki czyszczące i akcesoria	Codzienne użytkowanie
	Pojemnik i kosz myć miękką gąbką zwilżoną ciepłą wodą z dodatkiem płynu do mycia naczyń.	Przed przystąpieniem do czyszczenia odłączyć urządzenie od zasilania i zaczekać, aż ostygnie.
	Pojemnik i kosz są przystosowane do mycia w zmywarce.	Czyścić urządzenie po każdym użyciu.
	Grzałkę czyścić szczotką do czyszczenia. Zewnętrzne powierzchnie urządzenia czyścić wilgotną ściereczką.	

7. CO ZROBIĆ, GDY...

Problem	Sprawdzić, czy...
Nie można uruchomić urządzenia ani nim sterować.	<ul style="list-style-type: none"> • Urządzenie podłączono prawidłowo do źródła zasilania. • Ustawiono czas pieczenia.
Nie można wsunąć pojemnika do urządzenia.	<ul style="list-style-type: none"> • Kosz nie jest przepełniony. • Kosz jest prawidłowo umieszczony. Podczas umieszczania go w pojemniku powinno być słyszalne kliknięcie.
Z urządzenia wydobywa się biały dym.	<ul style="list-style-type: none"> • Przyrządzana potrawa nie jest tłusta. • Pojemnik i kosz są czyste.

8. DANE TECHNICZNE

8.1 Dane techniczne

Napięcie	220-240 V
Częstotliwość	50-60 Hz

1. PREZENTARE GENERALĂ

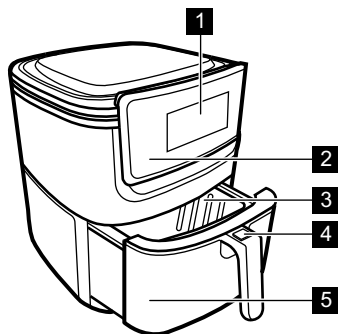

- 1** Afișaj
- 2** Panou de comandă
- 3** Coș
- 4** Încuietoare de siguranță cu capac de protecție
- 5** Cratiță



2. PANOUL DE COMANDĂ

2.1 Panou de comandă

Familiarizați-vă cu pictogramele de bază de pe panoul de comandă și afișaj.

 PORNIT/ OPRIT	 Sus	 Jos	 Temperatură	 Durata
---	--	--	--	---

Gătire asistată - gătiți cu setări automate pentru durată și temperatură.

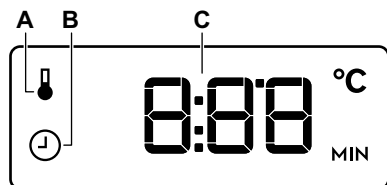

 Peste	 Friptură	 Pulpe de pui	 Pui
 Legume	 Cartofi prăjiți	 Mini pizza	 Briose

2.2 Afișaj



- A.** Reglaj temperatură
- B.** Setare durată
- C.** Durată / temperatură

3. ÎNAINTE DE PRIMA UTILIZARE

	Îndepărtați ambalajul, etichetele și folia protectoare.
	Curățați coșul și vasul cu apă caldă, lichid de vase și o lavetă moale. Uscați interiorul și exteriorul aparatului cu o lavetă moale.
	La prima utilizare, produsul poate degaja miros netoxic, care dispare imediat. Acest lucru nu afectează utilizarea.

4. UTILIZAREA ZILNICĂ

4.1 Modul de utilizare: vasul și coșul

Puneți aparatul pe o suprafață stabilă.

1. Scoateți vasul și puneți-l pe o suprafață stabilă.
2. Scoateți capacul de protecție de la încuietoarea de siguranță.
3. Apăsăți încuietoarea de siguranță pentru a scoate coșul.

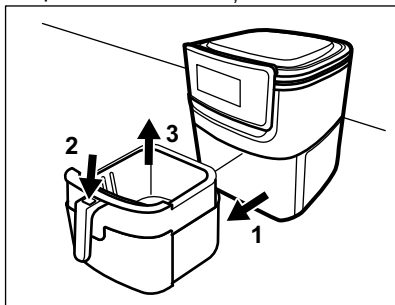

4. Introduceți alimentele în coș până la nivelul maxim. Capacitatea maximă a coșului este de 2 kg.

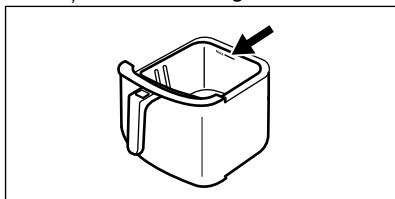









4.2 Cum se gătește

Introduceți alimentele în coș. Conectați aparatul.

1.  - apăsați lung.

2. Alegeți preparatul din Gătire asistată:

Simbol	Setare
	140 °C 15 min
	200 °C 10 min
	180 °C 20 min
	180 °C 45 min
	170 °C 15 min
	180 °C 15 min
	180 °C 10 min
	180 °C 15 min

3. Apăsăți: .

La sfârșitul gătirii, ventilatorul de răcire mai funcționează câteva secunde, apoi se aude semnalul.

Puteți modifica setările și opri aparatul în timpul gătirii:









- Apăsăți simbolul aliment pentru a modifica programul.







- ^, v - apăsați pentru a regla setările de timp sau temperatură.
- Ⓛ - apăsați lung timp de câteva secunde pentru a opri aparatul.

Scoateți aparatul din priză și așteptați să se răcească. Curățați vasul și coșul.

5. SFATURI PENTRU GĂTIRE

Temperatura și duratele de gătit din tabele au rol consultativ. Acestea depind de rețete și de calitatea și cantitatea ingredientelor utilizate.

	 (kg)	 (min)	 (°C)	
 Cartofi și legume				
Cartofi prăjiți, subțiri, congelat	0.3 - 0.7	9 - 16	180	Scuturați coșul
Cartofi prăjiți, groși, congelat	0.3 - 0.7	11 - 20	180	Scuturați coșul
Cartofi prăjiți(8 x 8 mm)	0.3 - 0.8	10 - 16	180	Scuturați coșul / Adăugați 1/2 de lingură de ulei
Cartofi wedges, proaspeți	0.3 - 0.8	18 - 22	180	Scuturați coșul / Adăugați 1/2 de lingură de ulei
Cubulețe de cartofi	0.3 - 0.75	12 - 18	180	Scuturați coșul / Adăugați 1/2 de lingură de ulei
Legume umplute	0.1 - 0.4	10	170	-
Legume	0.1 - 0.4	10	170	-
 Carne și pui				
Friptură	0.1 - 0.5	8 - 12	200	-
Cotlet de porc	0.1 - 0.5	10 - 14	200	-
Hamburger	0.1 - 0.5	7- 14	200	-
Pateuri cu carne	0.1 - 0.5	13 - 15	200	-
Pulpe de pui	0.1 - 0.5	18 - 22	180	-
Piept de pui	0.1 - 0.5	10 - 15	185	-
Pui	0.9 - 1.2	40 - 50	180	-
 Snacksuri				
Pachețele de primăvară, congelate	0.1 - 0.4	8 - 10	200	Scuturați coșul
Nuggets de pui, congelat	0.1 - 0.5	6 - 10	200	Scuturați coșul

	 (kg)	 (min)	 (°C)	
Degetele de pește pane, congelat	0.1 - 0.4	6 - 10	200	-
Snacksuri din brânză pane în pesmet, congelate	0.1 - 0.4	8 - 10	180	-
 Coacere				
Prăjituri	0.3	20 - 25	165	Utilizați o formă de gătit
Quiche	0.4	20 - 22	185	Utilizați o formă de gătit / vas pentru cuptor
Briose	0.3	15 - 18	200	Utilizați o formă de gătit

6. NOTE CU PRIVIRE LA CURĂȚARE

	<p>Agentii de curățare și accesoriile Curățați vasul și coșul cu un burete moale cu apă caldă și lichid de vase. Vasul și coșul se pot spăla la mașină. Curățați elementul de încălzire cu o perie de curățare. Curățați exteriorul aparatului cu o lavetă moale.</p>	<p>Utilizarea zilnică Înainte de curățare, scoateți aparatul din priză și așteptați să se răcească. Curățați aparatul după fiecare întrebuințare.</p>
---	--	--

7. CE TREBUIE FĂCUT DACĂ...

Problemă	Verificați dacă...
Aparatul nu poate fi pornit sau utilizat.	<ul style="list-style-type: none"> • Aparatul este conectat corect la o sursă de alimentare electrică. • Durata gătirii este setată.
Nu puteți introduce vasul în aparat.	<ul style="list-style-type: none"> • Coșul nu este umplut peste capacitatea sa maximă. • Coșul este poziționat corect. Acesta trebuie să facă un clic când este introdus în vas.
Din aparat iese fum alb.	<ul style="list-style-type: none"> • Mâncarea preparată nu este unsuroasă. • Vasul și coșul sunt curate.

8. DATE TEHNICE

8.1 Date tehnice

Tensiune	220 - 240 V
Frecvență	50 - 60 Hz

1. ОБЩИЙ ОБЗОР

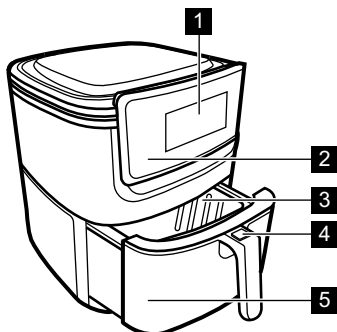

- 1** Дисплей
- 2** Панель управления
- 3** Корзина
- 4** Защитный блокиратор с крышкой
- 5** Поддон

2. ПАНЕЛЬ УПРАВЛЕНИЯ

2.1 Панель управления

Ознакомьтесь с основными значками на панели управления и дисплее.

«ВКЛ/ВЫКЛ»	Вверх	Вниз	Температура	Продолж.

Помощь в Приготовлении - приготовление с автоматически заданными настройками времени и температуры.

Рыба	Стейк	Куриные ножки	Цыпленок
Овощи	Картофель фри	Мини-пицца	Маффины

2.2 Дисплей

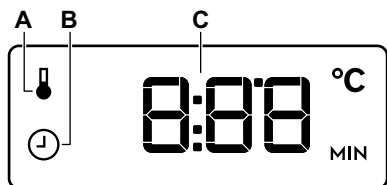

- A.** Уровень температуры
- B.** Установка параметров времени
- C.** Время / температура

3. ПЕРЕД ПЕРВЫМ ИСПОЛЬЗОВАНИЕМ



Удалите всю упаковку, наклейки и защитную пленку.



Промойте корзину и поддон в теплой воде, используя мягкую ткань и жидкое моющее средство.

Протрите сухой тканью прибор внутри и снаружи.



При первом использовании прибор может выделять нетоксичный запах, который сразу же исчезает. Это не влияет на его работу.

4. ЕЖЕДНЕВНОЕ ИСПОЛЬЗОВАНИЕ

4.1 Использование поддона и корзины

Установите прибор на устойчивой поверхности.

1. Снимите поддон и положите его на устойчивую поверхность.
2. Снимите защитную крышку блокиратора.
3. Выньте корзину, нажав на блокиратор.

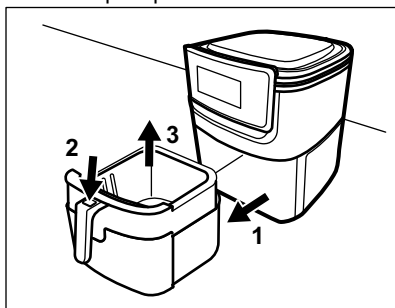

4. Выложите в корзину продукты, не превышая отметки максимальной загрузки. Максимальная емкость корзины составляет 2 кг.

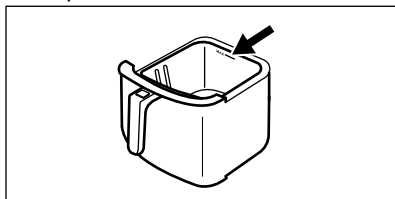

4.2 Приготовление

Поместите продукты в корзину.
Подключите прибор к сети питания.

1. Нажмите и удерживайте .
2. Выберите блюдо из списка функции «Помощь в приготовлении»:

Символ	Установка
	140°C 15 мин
	200°C 10 мин
	180°C 20 мин
	180°C 45 мин
	170°C 15 мин
	180°C 15 мин
	180°C 10 мин
	180°C 15 мин

3. Нажмите: .

По окончании приготовления на несколько секунд включится охлаждающий вентилятор, затем раздастся звуковой сигнал.

Во время приготовления можно изменить настройки или выключить прибор.







- Для изменения программы нажмите символ продукта.
- Нажмите \wedge , \vee для настройки времени или температуры.







- Нажмите и удерживайте Ⓜ в течение нескольких секунд, чтобы выключить прибор.

Вытащите вилку прибора из розетки и убедитесь в том, что он остыл. Очистите поддон и корзину.

5. СОВЕТЫ ПО ПРИГОТОВЛЕНИЮ

Приведенные в таблицах значения температуры и времени приготовления являются ориентировочными. Они зависят от рецепта, а также от качества и количества используемых ингредиентов.

	 (кг)	 (мин)	 (°C)	
 Картофель и овощи				
Картофель фри, тонк., заморож.	0.3 - 0.7	9 - 16	180	Встряхните корзину
Картофель фри, толстый., заморож.	0.3 - 0.7	11 - 20	180	Встряхните корзину
Картофель фри (8 x 8 мм)	0.3 - 0.8	10 - 16	180	Встряхните корзину / добавьте 1/2 столовой ложки растительного масла
Ломтики картофеля, свежие	0.3 - 0.8	18 - 22	180	Встряхните корзину / добавьте 1/2 столовой ложки растительного масла
Кубики картофеля	0.3 - 0.75	12 - 18	180	Встряхните корзину / добавьте 1/2 столовой ложки растительного масла
Фаршированные овощи	0.1 - 0.4	10	170	-
Овощи	0.1 - 0.4	10	170	-
 Мясо, рыба и птица				
Стейк	0.1 - 0.5	8 - 12	200	-
Свиньи отбивные	0.1 - 0.5	10 - 14	200	-
Гамбургеры	0.1 - 0.5	7- 14	200	-
Сосиски в тесте	0.1 - 0.5	13 - 15	200	-
Куриные ножки	0.1 - 0.5	18 - 22	180	-
Куриная грудка	0.1 - 0.5	10 - 15	185	-

	 (кг)	 (мин)	 (°C)	
Цыпленок	0.9 - 1.2	40 - 50	180	-
 Закуски				
Спринг-роллы, замороженные	0.1 - 0.4	8 - 10	200	Встряхните корзину
Кусочки курицы в панировке, заморож.	0.1 - 0.5	6 - 10	200	Встряхните корзину
Рыбные палочки, заморож.	0.1 - 0.4	6 - 10	200	-
Сырная закуска в панировке, заморож.	0.1 - 0.4	8 - 10	180	-
 Выпечка				
Пироги	0.3	20 - 25	165	Используйте форму для выпечки
Киш	0.4	20 - 22	185	Используйте форму для выпечки / посуду для выпечки
Маффины	0.3	15 - 18	200	Используйте форму для выпечки

6. ПРИМЕЧАНИЕ ОТНОСИТЕЛЬНО ОЧИСТКИ

	<p>Средства для очистки и аксессуары Мойте поддон и корзину мягкой губкой, смоченной теплой водой с моющим средством.</p> <p>Поддон и корзину можно мыть в посудомоечной машине.</p> <p>Очищайте нагревательный элемент с помощью щетки.</p> <p>Вытирайте прибор снаружи мягкой тряпкой.</p>	<p>Ежедневное использование Перед очисткой выньте вилку прибора из розетки и убедитесь, что он остыл.</p> <p>Прибор необходимо очищать от загрязнений после каждого использования.</p>
---	---	---

7. ЧТО ДЕЛАТЬ, ЕСЛИ...

Неисправность	Убедитесь, что...
Прибор не включается или не работает.	<ul style="list-style-type: none"> • Прибор подключен к сети электропитания надлежащим образом. • Задано время приготовления.

Неисправность	Убедитесь, что...
Не удается задвинуть поддон в прибор.	<ul style="list-style-type: none"> Загрузка корзины не превышает максимальной отметки. Корзина вставлена надлежащим образом. Она устанавливается в поддон со щелчком.
Из прибора выходит белый дым.	<ul style="list-style-type: none"> Готовящийся продукт не слишком жирный. Поддон и корзина чистые.

8. ТЕХНИЧЕСКИЕ ДАННЫЕ

8.1 Технические данные

Напряжение	220-240 В
Частота	50 - 60 Гц

Дата изготовления изделия указана в его серийном номере, где первая цифра номера соответствует последней цифре года изготовления, а вторая и третья цифры – порядковому номеру недели. Например, серийный номер 14512345 означает, что изделие изготовлено на сорок пятой неделе 2021 года.

Изготовитель: Electrolux Appliances AB, St. Göransgatan 143, 105 45 Stockholm, Швеция

Импортер и уполномоченная изготовителем организация:
ООО "Электролюкс Рус", Кожевнический проезд 1, 115114, Москва, тел.: 8-800-444-444-8

Изготовлено в Китае

1. ОПШТИ ПРИКАЗ

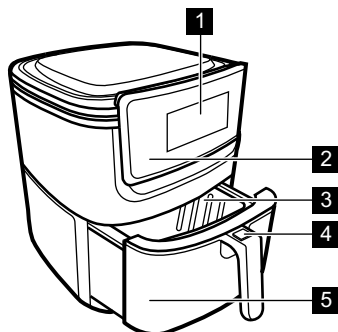

- 1** Дисплеј
- 2** Командна табла
- 3** Корпа
- 4** Сигурносна брава са заштитним поклопцем
- 5** Тигањ

2. КОМАНДНА ТАБЛА

2.1 Командна табла

Упознајте се са основним иконицама на командној табли и на дисплеју.

УКЉУЧЕНО/ ИСКЉУЧЕНО	Горе	Доле	Температура	Трајање

Кухање асистенцију - кувајте са аутоматским подешавањем времена и температуре.

Риба	Одрезак	Пилећи батаци	Пиле
Поврће	Помфрит	Мини пица	Мафини

2.2 Дисплеј

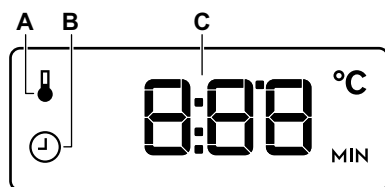

- A.** Подешавања температуре
- B.** Подешавање времена
- C.** Време / температура

3. ПРЕ ПРВЕ УПОТРЕБЕ



Уклоните комплетну амбалажу, налепнице и заштитну фолију.



Очистите корпу и плех топлом водом, течношћу за прање и меком крпом. Пребришите спољну и унутрашњу површину уређаја крпом.



При првој употреби производ може да испусти нетоксичан мирис који одмах нестаје. То не утиче на коришћење уређаја.

4. СВАКОДНЕВНА УПОТРЕБА

4.1 Како да користите: посуду и корпу

Поставите уређај на стабилну површину.

1. Уклоните посуду и ставите је на стабилну површину.
2. Уклоните заштитни поклопац са сигурносне браве.
3. Притисните сигурносну браву да бисзе уклонили корпу.

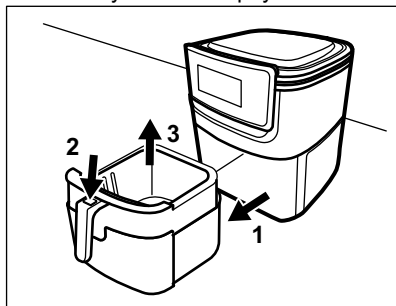

4. Ставите храну у корпу до максималног нивоа. Максимални капацитет корпе је 2 kg.

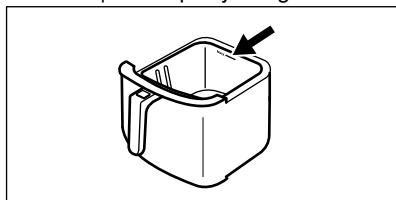

4.2 Како припремати храну

Ставите намирнице у корпу. Укључите апарат у струју.

1. – притисните и задржите.
2. Изаберите јело користећи Потпомогнуту припрему:

Симбол	Подешавање
	140 °C 15 min
	200 °C 10 min
	180 °C 20 min
	180 °C 45 min
	170 °C 15 min
	180 °C 15 min
	180 °C 10 min
	180 °C 15 min

3. Притисните: .
Кад се кување заврши, вентилатор за хлађење ради још неколико секунди, а затим се оглашава звучни сигнал.









Током кувања можете променити подешавања и искључити апарат:







- Притисните симбол хране да бисте променили програм.
- \wedge , \vee – притисните да бисте подесили време или температуру.
- ⓪ – притисните и држите неколико секунди да бисте искључили апарат.

Искључите апарат из струје и сачекајте да се охлади. Очистите плех и корпу.

5. САВЕТИ У ВЕЗИ СА КУВАЊЕМ

Температура и време кувања наведени у табелама су само оријентациони. Они зависе од рецепата, квалитета и количине употребљених састојака.

	 (kg)	 (min)	 (°C)	
 Кромпир и поврће				
Помфрит, танак, смрзнуто	0.3 - 0.7	9 - 16	180	Протресите корпу
Помфрит, дебео, смрзнуто	0.3 - 0.7	11 - 20	180	Протресите корпу
Помфрит (8 mm x 8 mm)	0.3 - 0.8	10 - 16	180	Протресите корпу / Додајте 1/2 кашике уља
Исечени кромпир, свеж	0.3 - 0.8	18 - 22	180	Протресите корпу / Додајте 1/2 кашике уља
Коцкице од кромпира	0.3 - 0.75	12 - 18	180	Протресите корпу / Додајте 1/2 кашике уља
Пуњено поврће	0.1 - 0.4	10	170	-
Поврће	0.1 - 0.4	10	170	-
 Месо и живина				
Одрезак	0.1 - 0.5	8 - 12	200	-
Свињски одресци	0.1 - 0.5	10 - 14	200	-
Пљескавица	0.1 - 0.5	7- 14	200	-
Рол-виршле	0.1 - 0.5	13 - 15	200	-
Пилећи батаци	0.1 - 0.5	18 - 22	180	-
Пилеће груди	0.1 - 0.5	10 - 15	185	-
Пиле	0.9 - 1.2	40 - 50	180	-
 Закуске				

	 (kg)	 (min)	 (°C)	
Земичке, замрзнуте	0.1 - 0.4	8 - 10	200	Протресите корпу
Пилећи медаљони, смрзнуто	0.1 - 0.5	6 - 10	200	Протресите корпу
Рибљи штапићи, смрзнуто	0.1 - 0.4	6 - 10	200	-
Грицкалице од сира у презлама, смрзнуте	0.1 - 0.4	8 - 10	180	-
 Печење				
Колачи	0.3	20 - 25	165	Користите плех за печење
Киш	0.4	20 - 22	185	Користите плех за печење / посуђе за рерну
Мафини	0.3	15 - 18	200	Користите плех за печење

6. НАПОМЕНЕ У ВЕЗИ СА ЧИШЋЕЊЕМ

	Средства за чишћење и прибор	Свакодневна употреба
	<p>Очистите посуду и корпу меким сунђером користећи топлу воду и течност за прање. Посуда и корпа могу се прати у машини за прање судова.</p> <p>Очистите грејни елемент четком за чишћење.</p> <p>Очистите спољну страну уређаја меком крпом.</p>	<p>Пре чишћења искључите уређај из мреже и сачекајте да се охлади.</p> <p>Уређај очистите након сваке употребе.</p>

7. ШТА УЧИНИТИ АКО...

Проблем	Проверите да ли...
Не можете да укључите уређај нити да га користите.	<ul style="list-style-type: none"> Уређај је правилно прикључен на електричну мрежу. Време кувања је подешено.
Не можете да убаците посуду у уређај.	<ul style="list-style-type: none"> Корпа није напуњена преко њеног максималног капацитета. Корпа је правилно постављена. Треба да кликне када је убаците у посуду.
Из уређаја излази бели дим.	<ul style="list-style-type: none"> Храна коју припремате није масна. Посуда и корпа су чисте.

8. ТЕХНИЧКИ ПОДАЦИ

8.1 Технички подаци

Напон	220 - 240 V
Фреквенција	50 - 60 Hz

1. CELKOVÝ PREHĽAD

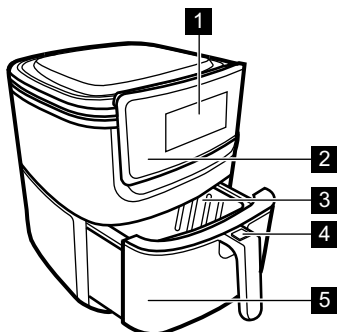

- 1** Displej
- 2** Ovládací panel
- 3** Kôš
- 4** Bezpečnostný zámok s ochranným krytom
- 5** Pekáč

2. OVLÁDACÍ PANEL

2.1 Ovládací panel

Oboznámte sa so základnými ikonami na ovládacom paneli a displeji.

ZAP/VYP	Hore	Dole	Teplota	Trvanie

Sprievodca pečením – pečte s automatickými nastaveniami času a teploty.

Ryba	Steak	Kuracie stehná	Kurča
Zelenina	Hranolčky	Minipizza	Muffiny

2.2 Displej

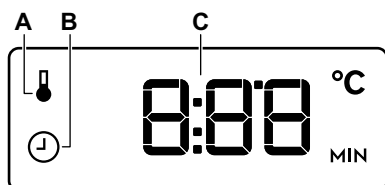

- A.** Nastavenie teploty
- B.** Nastavenie času
- C.** Čas / teplota

3. PRED PRVÝM POUŽITÍM



Odstráňte všetky obaly, štítky a ochrannú fóliu.



Očistite kôš a panvicu teplou vodou, prípravkom na umývanie riadu a mäkkou handričkou.

Vysušte vnútro a vonkajšiu časť spotrebiča handričkou.



Pri prvom použití výrobok môže uvoľňovať netoxický zápach, ktorý okamžite zmizne. Toto nemá vplyv na jeho použitie.

4. KAŽDODENNÉ POUŽÍVANIE

4.1 Používanie: pekáč a kôš

Spotrebič položte na stabilný povrch.

1. Vyberte pekáč a položte ho na stabilný povrch.
2. Vyberte ochranný kryt na bezpečnostnom zámku.
3. Stlačte bezpečnostný zámok, aby ste vybrali kôš.

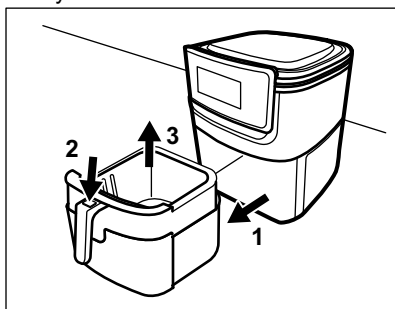

4. Naplňte kôš jedlom po maximálnej úrovni. Maximálny objem koša je 2 kg.

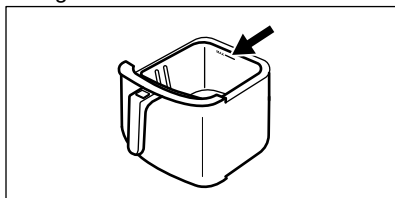

4.2 Príprava jedla

Jedlo vložte do koša. Zapojte spotrebič.

1. ① – stlačte a podržte.
2. Vyberte pokrm zo Sprievodcu pečením:

Symbol	Nastavenie
	140 °C 15 min
	200 °C 10 min
	180 °C 20 min
	180 °C 45 min
	170 °C 15 min
	180 °C 15 min
	180 °C 10 min
	180 °C 15 min

3. Stlačte tlačidlo: ①.

Keď sa príprava jedla skončí, chladiaci ventilátor je v činnosti pár sekúnd, potom zaznie zvukový signál.

Počas prípravy jedla môžete zmeniť nastavenia a vypnúť spotrebič:









- Stlačte symbol jedla, aby ste zmenili program.







- ^, v – stlačte, aby ste upravili nastavenia času alebo teploty.
- ① – stlačte a podržte na niekoľko sekúnd, aby ste vyplli spotrebič.

Spotrebič odpojte od elektrickej siete a počkajte, až kým nevychladne. Vyčistite pekáč a kôš.

5. RADY NA PEČENIE

Teploty a časy pečenia uvedené v tabuľkách sú iba orientačné. Závajú od konkrétneho receptu, množstva a kvality použitých prísad.

	 (kg)	 (min)	 (°C)	
 Zemiaky a zelenina				
Hranolky, tenké, mrazené	0.3 - 0.7	9 - 16	180	Potraste košom
Hranolky, hrubé, mrazené	0.3 - 0.7	11 - 20	180	Potraste košom
Hranolčeky (8 x 8 mm)	0.3 - 0.8	10 - 16	180	Potraste košom / Pridajte 1/2 polievkovej lyžice oleja
Americké zemiaky	0.3 - 0.8	18 - 22	180	Potraste košom / Pridajte 1/2 polievkovej lyžice oleja
Zemiaky na kocky	0.3 - 0.75	12 - 18	180	Potraste košom / Pridajte 1/2 polievkovej lyžice oleja
Plnená zelenina	0.1 - 0.4	10	170	-
Zelenina	0.1 - 0.4	10	170	-
 Mäso a hydina				
Steak	0.1 - 0.5	8 - 12	200	-
Bravčové kotlety (hrubšie a s kosťou)	0.1 - 0.5	10 - 14	200	-
Hamburger	0.1 - 0.5	7 - 14	200	-
Údeninové rolky	0.1 - 0.5	13 - 15	200	-
Kuracie stehná	0.1 - 0.5	18 - 22	180	-
Kuracie prsia	0.1 - 0.5	10 - 15	185	-
Kurča	0.9 - 1.2	40 - 50	180	-
 Malé pokrmy				
Jarné závitky, mrazené	0.1 - 0.4	8 - 10	200	Potraste košom
Kurča vcelku, mrazené	0.1 - 0.5	6 - 10	200	Potraste košom

	 (kg)	 (min)	 (°C)	
Rybíe prsty, mrazené	0.1 - 0.4	6 - 10	200	-
Strúhankové syrové chuťovky, mrazené	0.1 - 0.4	8 - 10	180	-
 Pečenie				
Koláče	0.3	20 - 25	165	Použite formu na pečenie
Slaný koláč	0.4	20 - 22	185	Použite formu na pečenie / riad do rúry
Muffiny	0.3	15 - 18	200	Použite formu na pečenie

6. POZNÁMKY K ČISTENIU

	Čistiace prostriedky a príslušenstvo	Každodenné používanie
	<p>Pekáč a kôš očistite mäkkou utierkou namočenou v teplej vode s prídavkom saponátu. Pekáč a kôš sú vhodné do umývačky riadu. Ohrevný článok vyčistíte čistiacou kefkou. Vonkajšok spotrebiča očistíte vlhkou handričkou.</p>	<p>Spotrebič pred čistením odpojte od elektrickej siete a počkajte, kým nevychladne. Spotrebič vyčistíte po každom použití.</p>

7. ČO ROBIŤ, KEĎ...

Problém	Skontrolujte, či...
Spotrebič sa nedá zapnúť ani používať.	<ul style="list-style-type: none"> Spotrebič je správne pripojený ku zdroju elektrického napájania. Bola nastavená doba pečenia.
Nemôžete vsunúť pekáč do spotrebiča.	<ul style="list-style-type: none"> Kôš nie je naplnený nad maximálnu kapacitu. Kôš je vložený správne. Pri vložení do pekáča musí zaklapnúť.
Zo spotrebiča vychádza biely dym.	<ul style="list-style-type: none"> Jedlo, ktoré pripravujete, nie je masné. Pekáč a kôš sú čisté.

8. TECHNICKÉ ÚDAJE

8.1 Technické údaje

Napätie	220 – 240 V
Frekvencia	50 - 60 Hz

1. SPLOŠNI PREGLED

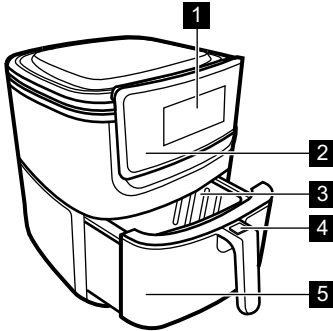





- 1** Prikazovalnik
- 2** Upravljalna plošča
- 3** Košara
- 4** Varnostni zaklep z zaščitnim pokrovom
- 5** Pekač

2. UPRAVLJALNA PLOŠČA

2.1 Upravljalna plošča

Seznanite se z osnovnimi ikonami na upravljalni plošči in prikazovalniku.

				
VKLOP/ IZKLOP	Gor	Dol	Temperatura	Trajanje

Kuharski pomočnik - kuhajte s samodejnimi nastavitvami časa in temperature.

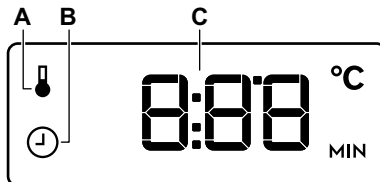

			
Ribe	Zrezek	Piščančja bedra	Piščanec
			
Zelenjava	Ocvrti krompir	Mini pizza	Mafini

2.2 Prikazovalnik



- A.** Nastavitev temperature
- B.** Nastavitev časa
- C.** Čas/Temperatura

3. PRED PRVO UPORABO

	Odstranite vso embalažo, etikete in zaščitno folijo.
	Očistite košaro in pekač s toplo vodo, tekočino za pomivanje in mehko krpo. Notranjost in zunanost naprave osušite s krpo.
	Ob prvi uporabi lahko izdelek oddaja nestrupen vonj, ki takoj izzzveni. To ne vpliva na uporabo izdelka.

4. VSAKODNEVNA UPORABA

4.1 Uporaba: pekača in košare

Napravo postavite na stabilno površino.

1. Odstranite pekač in ga postavite na stabilno površino.
2. Odstranite zaščitni pokrov na varnostnem zaklepu.
3. Pritisnite varnostni zaklep, da odstranite košaro.

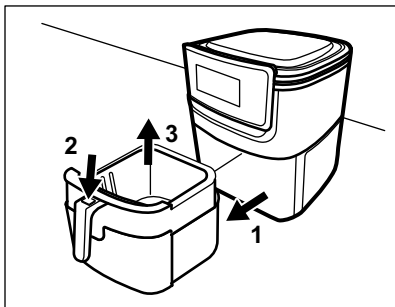

4. Živila zložite v košaro do najvišje ravni. V košaro lahko zložite največ 2 kg.

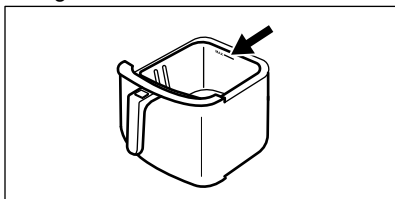









4.2 Pečenje

Hrano položite v košaro. Vključite napravo.

1.  – pritisnite in držite.

2. Izberite jed iz kuharskega pomočnika:



Simbol	Nastavitev:
	140 °C 15 min.
	200 °C 10 min.
	180 °C 20 min.
	180 °C 45 min.
	170 °C 15 min.
	180 °C 15 min.
	180 °C 10 min.
	180 °C 15 min.

3. Pritisnite: .

Po koncu kuhanja ventilator deluje nekaj sekund, nato se sproži zvočni signal.

Med pečenjem lahko spremenite nastavitve in izklopite napravo:









- Za spremembo programa pritisnite simbol za živila.







- ,  – pritisnite za nastavitev časa ali temperature.
-  – pritisnite in držite nekaj sekund za izklop naprave.

Izključite napravo in počakajte, da se ohladi. Očistite pekač in košaro.

5. NASVETI ZA PEČENJE

Temperature in časi pečenja v razpredelnih so le smernice. Odvisni so od recepta, kakovosti in količine uporabljenih sestavin.

	 (kg)	 (min.)	 (°C)	
 Krompir in zelenjava				
Ocvrti krompir, tanek, zamrznjen	0.3 - 0.7	9 - 16	180	Stresite košaro
Ocvrti krompir, debel, zamrznjen	0.3 - 0.7	11 - 20	180	Stresite košaro
Ocvrti krompir (8 x 8 mm)	0.3 - 0.8	10 - 16	180	Stresite košaro/Dodajte 1/2 žlice olja
Krompirjevi krlji, sveži	0.3 - 0.8	18 - 22	180	Stresite košaro/Dodajte 1/2 žlice olja
Krompirjeve kocke	0.3 - 0.75	12 - 18	180	Stresite košaro/Dodajte 1/2 žlice olja
Polnjena zelenjava	0.1 - 0.4	10	170	-
Zelenjava	0.1 - 0.4	10	170	-
 Meso in perutnina				
Zrezek	0.1 - 0.5	8 - 12	200	-
Svinjski kotleti	0.1 - 0.5	10 - 14	200	-
Hamburger	0.1 - 0.5	7- 14	200	-
Mesni zvitki	0.1 - 0.5	13 - 15	200	-
Piščančja bedra	0.1 - 0.5	18 - 22	180	-
Piščančje prsi	0.1 - 0.5	10 - 15	185	-
Piščanec	0.9 - 1.2	40 - 50	180	-
 Prigrizki				
Spomladanski zvitki, zamrznjeni	0.1 - 0.4	8 - 10	200	Stresite košaro
Piščančji medaljoni, zamrznjeni	0.1 - 0.5	6 - 10	200	Stresite košaro

	 (kg)	 (min.)	 (°C)	
Ribje palčke, zamrznjene	0.1 - 0.4	6 - 10	200	-
Sirovi prigrizki, zamrznjeni	0.1 - 0.4	8 - 10	180	-
 Pečenje kruha in peciva				
Pecivo	0.3	20 - 25	165	Uporabite pekač
Kiš	0.4	20 - 22	185	Uporabite pekač/posodo za pečico
Mafini	0.3	15 - 18	200	Uporabite pekač

6. OPOMBE GLEDE ČIŠČENJA

	Čistilna sredstva in dodatki	Vsakodnevna uporaba
	<p>Pekač in košaro očistite z mehko gobico, toplo vodo in sredstvom za pomivanje.</p> <p>Pekač in košara sta primerna za pomivanje v pomivalnem stroju.</p> <p>Grelec čistite s čistilno ščetko.</p> <p>Zunanost naprave čistite s mehko krpo.</p>	<p>Pred čiščenjem izključite napravo in počakajte, da se ohladi.</p> <p>Napravo po vsaki uporabi očistite.</p>

7. KAJ STORITE V PRIMERU ...

Težava	Preverite, če ...
Naprave ni mogoče vklopiti ali je uporabljati.	<ul style="list-style-type: none"> Naprava je pravilno priključena na napajanje. Čas pečenja je nastavljen.
Pekača ne morete potisniti v napravo.	<ul style="list-style-type: none"> Košara ni povsem napolnjena. Košara je nameščena pravilno. Ko jo položite v pekač, se mora zaskočiti.
Iz naprave prihaja bel dim.	<ul style="list-style-type: none"> Živila, ki jih pripravljate, niso mastna. Pekač in košara sta čista.

8. TEHNIČNI PODATKI

8.1 Tehnični podatki

Napetost	220 - 240 V
Frekvenca	50 - 60 Hz

1. ALLMÄN ÖVERSIKT

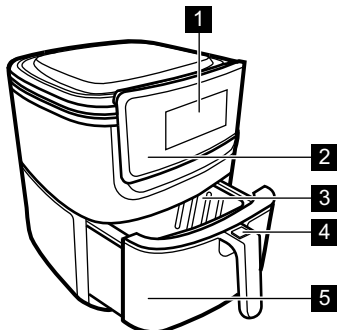





- 1** Display
- 2** Kontrollpanel
- 3** Korg
- 4** Säkerhetslås med skyddslock
- 5** Form

2. KONTROLLPANELEN

2.1 Kontrollpanel

Bekanta dig med de grundläggande ikonerna på kontrollpanelen och på skärmen.

 PÅ/AV (ON/ OFF)	 Upp	 Ner	 Temperatur	 Koktid
---	--	--	---	---

Tillagningshjälp - tillaga med automatiska tids- och temperaturinställningar.

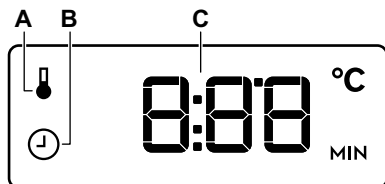

 Fisk	 Biff	 Kycklinglår	 Kyckling
 Grönsaker	 Pommes Frites	 Minipizza	 Muffins

2.2 Display



- A.** Värmeläge
- B.** Ställa in klockan
- C.** Tid/temperatur

3. FÖRE FÖRSTA ANVÄNDNING

	Ta bort alla förpackningsdelar, etiketter och skyddsfilm.
	Rengör korgen och formen med varmt vatten, diskmedel och en mjuk trasa. Torka torrt på insidan och utsidan med en handduk.
	Vid den första användningen kan produkten avge en lukt som inte är giftig och som försvinner omedelbart. Detta påverkar inte användningen.

4. DAGLIG ANVÄNDNING

4.1 Användning: form och korg

Placera produkten på en stabil yta.

1. Ta bort formen och placera den på en stabil yta.
2. Ta bort skyddet på säkerhetslåset.
3. Tryck på säkerhetslåset för att ta bort korgen.

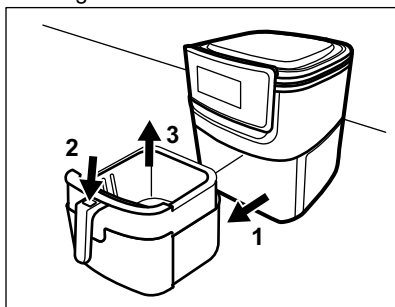



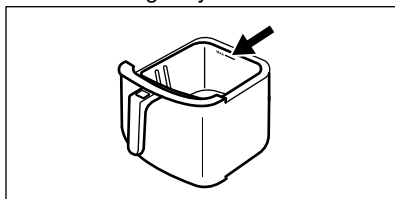





4. Lägg mat i korgen upp till maximala nivån. Korgen rymmer maximalt 2 kg.



4.2 Hur man tillagar mat

Lägg maten i korgen. Koppla in apparaten i eluttaget.



1.  – tryck och håll in.
2. Välj maträtt från Tillagningshjälp:

Symbol	Inställning
	140 °C 15 min
	200 °C 10 min
	180 °C 20 min
	180 °C 45 min
	170 °C 15 min
	180 °C 15 min
	180 °C 10 min
	180 °C 15 min

3. Tryck på: .

När tillagningen är klar startar kylfläkten i några sekunder och sedan avges en ljudsignal.









Du kan ändra inställningar och stänga av apparaten under tillagning:







- Tryck på matsymbolen för att byta program.
- ,  – tryck för att ändra inställning av tid eller temperatur.

-  – tryck och håll in i några sekunder för att stänga av apparaten. Koppla ur apparaten och vänta tills den har svalnat. Rengör formen och korgen.

5. MATLAGNINGSTIPS

Temperaturen och gräddningstiderna i tabellerna är endast riktvärden. De beror på recepten samt på ingrediensernas kvalitet och mängd.

	 (kg)	 (min.)	 (°C)	
 Potatis och grönsaker				
Pommes Frites, tunna, fryst	0.3 - 0.7	9 - 16	180	Skaka korgen
Pommes Frites, tjocka, fryst	0.3 - 0.7	11 - 20	180	Skaka korgen
Pommes Frites(8 x 8 mm)	0.3 - 0.8	10 - 16	180	Skaka korgen/ tillsätt 1/2 msk olja
Potatisklyftor, färska	0.3 - 0.8	18 - 22	180	Skaka korgen/ tillsätt 1/2 msk olja
Potatis i tärningar	0.3 - 0.75	12 - 18	180	Skaka korgen/ tillsätt 1/2 msk olja
Fyllda grönsaker	0.1 - 0.4	10	170	-
Grönsaker	0.1 - 0.4	10	170	-
 Kött och fågel				
Biff	0.1 - 0.5	8 - 12	200	-
Fläskkotletter	0.1 - 0.5	10 - 14	200	-
Hamburgare	0.1 - 0.5	7- 14	200	-
Inbakad korv	0.1 - 0.5	13 - 15	200	-
Kycklinglår	0.1 - 0.5	18 - 22	180	-
Kycklingbröst	0.1 - 0.5	10 - 15	185	-
Kyckling	0.9 - 1.2	40 - 50	180	-
 Tilltugg				
Vårullar, frysta	0.1 - 0.4	8 - 10	200	Skaka korgen
Chicken nuggets, fryst	0.1 - 0.5	6 - 10	200	Skaka korgen
Fiskpinnar, fryst	0.1 - 0.4	6 - 10	200	-
Panerade ostsnacks, frysta	0.1 - 0.4	8 - 10	180	-

		 (kg)	 (min.)	 (°C)	
 Gräddning					
Kakor		0.3	20 - 25	165	Använd en bakform
Quiche		0.4	20 - 22	185	Använd en bakform/ugnsform
Muffins		0.3	15 - 18	200	Använd en bakform

6. ANMÄRKNINGAR OM RENGÖRING

	Rengöringsmedel och tillbehör	Daglig användning
	<p>Torka av formen och korgen med en mjuk trasa med varmt vatten och diskmedel.</p> <p>Formen och korgen går att diska i diskmaskinen.</p> <p>Rengör värmeelementet med en rengöringsborste.</p> <p>Rengör produktens utsida med en mjuk trasa.</p>	<p>Koppla ur produkten och vänta tills den är kallt innan den rengörs.</p> <p>Rengör produkten efter varje användningstillfälle.</p>

7. OM PRODUKTEN INTE FUNGERAR ...

Problem	Kontrollera att...
Det går inte att aktivera eller använda produkten.	<ul style="list-style-type: none"> • Produkten är korrekt ansluten till strömförsörjningen. • Tillagningstiden är inställd.
Formen kan inte sättas in i produkten.	<ul style="list-style-type: none"> • Korgen inte är fylld över maximal kapacitet. • Korgen är placerad korrekt. Det ska klicka när du sätter in formen.
Vit rök kommer ut.	<ul style="list-style-type: none"> • Maten du lagar är inte fet. • Formen och korgen är rena.

8. TEKNISKA DATA

8.1 Tekniska data

Nätspänning	220 - 240 V
Frekvens	50 - 60 Hz

1. GENEL BAKIŞ

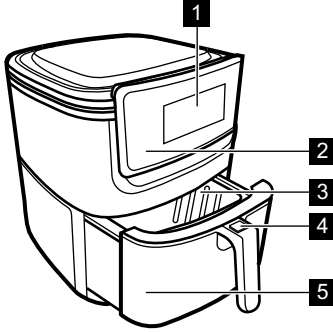

- 1 Gösterge Ekranı
- 2 Kontrol paneli
- 3 Sepet
- 4 Koruma kapaklı emniyet kilidi
- 5 Tava/Pişirme kabı

2. KONTROL PANELİ

2.1 Kontrol paneli

Kontrol paneli ve ekran üzerindeki temel simgeler hakkında bilgi edinin.

AÇIK/KAPALI	Yukarı	Aşağı	Sıcaklık	Süre

Yardımlı Pişirme - otomatik süre ve sıcaklık ayarlarıyla pişirin.

Balık	Biftek	Tavuk baget	Tavuk
Sebzeler	Patates kızartması	Mini pizza	Muffin

2.2 Gösterge Ekranı

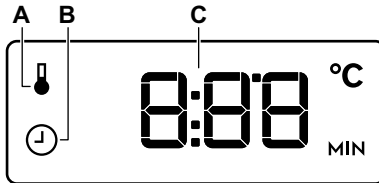

- A. Sıcaklık ayarı
- B. Zaman ayarı
- C. Zaman / sıcaklık

3. İLK KULLANIMDAN ÖNCE



Ürünün kutusunu, etiketlerini ve koruyucu filmlerini tamamen çıkarın.



Sepeti ve tavayı ılık su, sıvı bulaşık deterjanı ve yumuşak bir bezle temizleyin. Cihazın içini ve dışını bir bezle kurulayın.



Ürün, ilk kullanım sırasında zararsız ve hemen kaybolan bir koku salabilir. Bu kullanımı etkilemez.

4. GÜNLÜK KULLANIM

4.1 Kullanım şekli: tava ve sepet

Cihazı sabit bir yüzeye koyun.

1. Tavayı çıkarın ve sabit bir yüzeye yerleştirin.
2. Güvenlik kilidindeki koruma kapağını çıkarın.
3. Sepeti çıkarmak için emniyet kilidine basın.

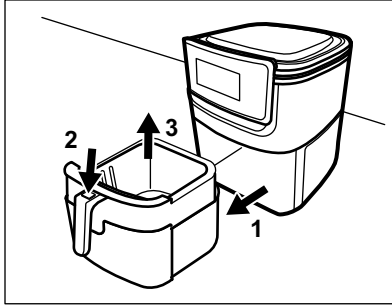

4. Sepete yiyecekleri maksimum seviyeye kadar koyun. Sepetin maksimum kapasitesi 2 kg'dır.

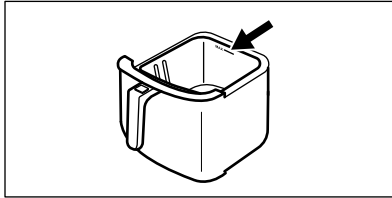

4.2 Nasıl pişirilir

Yiyeceği sepete koyun. Cihazı prize takın.

1. ① - basılı tutun.

2. Yardımlı pişirme'den yemeği seçin:

Sembol	Ayarlar
	140 °C 15 dk.
	200 °C 10 dk.
	180 °C 20 dk.
	180 °C 45 dk.
	170 °C 15 dk.
	180 °C 15 dk.
	180 °C 10 dk.
	180 °C 15 dk.

3. Şuna basın: ①.

Pişirme sona erdiğinde soğutma fanı bir kaç saniye daha çalışır ve sonrasında bir sinyal sesi duyulur.

Pişirme sırasında ayarları değiştirebilir ve cihazı kapatabilirsiniz:









- Programı değiştirmek için yiyecek sembolüne basın.
- \wedge , \vee - zaman veya sıcaklık ayarlarını ayarlamak için basın.







- ⏸ - cihazı kapatmak için birkaç saniye basılı tutun.

Cihazı fişten çekin ve soğuyana kadar bekleyin. Tavayı ve sepeti temizleyin.

5. PIŞIRME İPUÇLARI

Tablolarda verilen sıcaklıklar ve pişirme süreleri sadece bilgi amaçlıdır. Gerçek süreler, tariflere ve kullanılan malzemelerin kalitesine ve miktarına bağlıdır.

	 (kg)	 (min)	 (°C)	
 Patates ve sebzeler				
Patates kızartması, ince, dondurulmuş	0.3 - 0.7	9 - 16	180	Sepeti sallayın
Patates kızartması, kalın, dondurulmuş	0.3 - 0.7	11 - 20	180	Sepeti sallayın
Patates kızartması(8 x 8 mm)	0.3 - 0.8	10 - 16	180	Sepeti sallayın / 1/2 yemek kaşığı yağ ekleyin
Patates dilimleri, taze	0.3 - 0.8	18 - 22	180	Sepeti sallayın / 1/2 yemek kaşığı yağ ekleyin
Patates küpleri	0.3 - 0.75	12 - 18	180	Sepeti sallayın / 1/2 yemek kaşığı yağ ekleyin
Sebze dolması	0.1 - 0.4	10	170	-
Sebzeler	0.1 - 0.4	10	170	-
 Et ve kümes hayvanları				
Biftek	0.1 - 0.5	8 - 12	200	-
Keçi eti pizolalar	0.1 - 0.5	10 - 14	200	-
Hamburger	0.1 - 0.5	7- 14	200	-
Sosisli ekmek	0.1 - 0.5	13 - 15	200	-
Tavuk baget	0.1 - 0.5	18 - 22	180	-
Tavuk göğsü	0.1 - 0.5	10 - 15	185	-
Tavuk	0.9 - 1.2	40 - 50	180	-
 Atıştırmalıklar				
Sigara böreği, dondurulmuş	0.1 - 0.4	8 - 10	200	Sepeti sallayın

	 (kg)	 (min)	 (°C)	
Tavuk parçaları, dondurulmuş	0.1 - 0.5	6 - 10	200	Sepeti sallayın
Balık kroket, dondurulmuş	0.1 - 0.4	6 - 10	200	-
Ekmek gibi ufalanmış peynirli atıştırmalıklar, dondurulmuş	0.1 - 0.4	8 - 10	180	-
 Pişirme				
Kek ve pastalar	0.3	20 - 25	165	Pişirme kabı kullanın
Kişi	0.4	20 - 22	185	Pişirme kabı / fırın kabı kullanın
Muffin	0.3	15 - 18	200	Pişirme kabı kullanın

6. TEMİZLİK HAKKINDA AÇIKLAMALAR

 <p>Temizlik maddeleri ve aksesuarları Tavayı ve sepeti ılık su ve bulaşık deterjanı kullanarak yumuşak bir süngerle temizleyin. Tava ve sepet bulaşık makinesinde yıkanabilir. Isıtma elemanını bir temizlik fırçasıyla temizleyin. Cihazın dışını yumuşak bir bezle temizleyin.</p>	<p>Günlük kullanım Temizlemeden önce cihazın fişini çekin ve soğuyana kadar bekleyin. Her kullanımdan sonra cihazı temizleyin.</p>
---	---

7. BU DURUMLARDA NE YAPMALI...

Problem	Aşağıdakileri kontrol ediniz...
Cihaz açılmıyor veya çalışmıyor.	<ul style="list-style-type: none"> Cihaz doğru şekilde bir elektrik prizine bağlanmış. Pişirme süresi ayarlanmıştır.
Tavayı cihaza kaydıramazsınız.	<ul style="list-style-type: none"> Sepet maksimum kapasitesinin üzerinde dolu değil. Sepet doğru şekilde yerleştirilmiş. Tava ya yerleştirdiğinizde tıklama sesi gelmelidir.
Cihazdan beyaz duman çıkmakta.	<ul style="list-style-type: none"> Hazırladığınız yiyecek yağlı değil. Tava ve sepet bulaşık temiz.

8. TEKNİK VERİLER

8.1 Teknik veriler

Voltaj	220 - 240 V
Sıklık	50 - 60 Hz

1. ЗАГАЛЬНИЙ ОГЛЯД

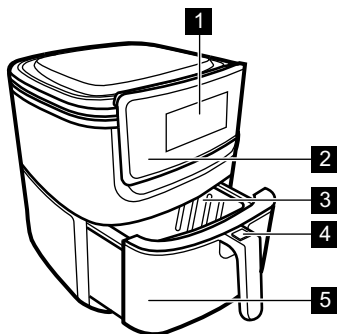

- 1** Дисплей
- 2** Панель керування
- 3** Кошик
- 4** Фіксуєчий замок із захисною кришкою
- 5** Деко

2. ПАНЕЛЬ КЕРУВАННЯ

2.1 Панель керування

Ознайомтеся з основними символами на панелі керування та дисплеї.				
				
УВИМК./ВИМК.	Вгору	Вниз	Температура	Тривалість
Допоможене приготування - готування з автоматичними налаштуванням часу і температури.				
				
Риба	Стейк	Курячі ніжки	Курка	
				
Овочі	Картопля фрі	Міні-піца	Кекс	

2.2 Дисплей

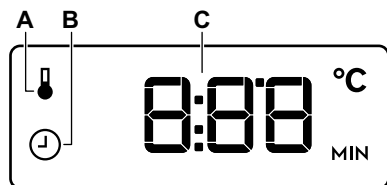

- A.** Ступіть нагріву
- B.** Налаштування часу
- C.** Час / температура

3. ПЕРЕД ПЕРШИМ ВИКОРИСТАННЯМ



Зніміть усі пакувальні матеріали, етикетки та захисну плівку.



Промийте кошик і чашу м'якою ганчіркою з теплою водою та засобом для миття посуду.
Протріть насухо всередині та зовні серветкою.



Під час першого використання виробу може з'явитися запах. Він є нетоксичним і швидко зникає. Це не впливає на ефективність використання виробу.

4. ЩОДЕННЕ ВИКОРИСТАННЯ

4.1 Як користуватися: чаша і кошик

Встановіть прилад на стійкій поверхні.

1. Вийміть чашу та встановіть її на стійку поверхню.
2. Зніміть захисну кришку з фіксуючого замка.
3. Натисніть на фіксуючий замок, щоб вийняти кошик.

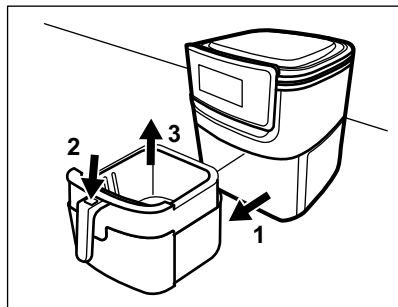

4. Покладіть продукти у кошик до максимального рівня.
Максимальна ємність кошика 2 кг.

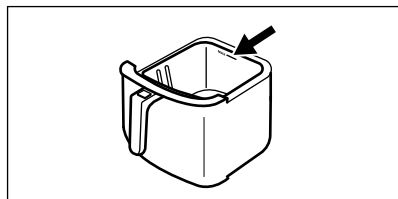

4.2 Як готувати

Покладіть продукти в кошик.
Підключіть прилад до електромережі.

1. — натисніть і утримуйте.

2. Виберіть страву в меню «Допомога при готуванні».

Символ	Налаштування
	140 °C 15 хв
	200 °C 10 хв
	180 °C 20 хв
	180 °C 45 хв
	170 °C 15 хв
	180 °C 15 хв
	180 °C 10 хв
	180 °C 15 хв

3. Натисніть: .

Після завершення готування охолоджувальний вентилятор працює протягом кількох секунд, а потім лунає звуковий сигнал.

Під час приготування можна змінити налаштування й вимкнути прилад.







- Натисніть символ продукту, щоб змінити програму.
- \wedge , \vee — натисніть для регулювання налаштувань часу чи температури.







-  — натисніть і утримуйте кілька секунд, щоб вимкнути прилад.

Від'єднайте прилад від електромережі й зачекайте, доки він охолоне. Очистіть чашу й кошик.

5. ПОРАДИ ЩОДО ГОТУВАННЯ

У таблицях вказані орієнтовні значення температури та часу приготування. Вони залежать від рецепту, а також якості й кількості інгредієнтів, що використовуються.

	 (кг)	 (хв.)	 (°C)	
 Картопля та овочі				
Картопля фрі, тонкими шматочками, заморожені	0.3 - 0.7	9 - 16	180	Потрусіть кошик
Картопля фрі, товстими шматочками, заморожені	0.3 - 0.7	11 - 20	180	Потрусіть кошик
Картопля фрі (8 x 8 мм)	0.3 - 0.8	10 - 16	180	Потрусіть кошик / Додайте 1/2 столової ложки олії
Картопляні скибочки, свіжі	0.3 - 0.8	18 - 22	180	Потрусіть кошик / Додайте 1/2 столової ложки олії
Картопляні кубики	0.3 - 0.75	12 - 18	180	Потрусіть кошик / Додайте 1/2 столової ложки олії
Фаршировані овочі	0.1 - 0.4	10	170	-
Овочі	0.1 - 0.4	10	170	-
 М'ясо та птиця				
Стейк	0.1 - 0.5	8 - 12	200	-
Відбивні котлети	0.1 - 0.5	10 - 14	200	-
Гамбургер	0.1 - 0.5	7 - 14	200	-
Булочки з сосисками	0.1 - 0.5	13 - 15	200	-
Курячі ніжки	0.1 - 0.5	18 - 22	180	-
Куряча грудина	0.1 - 0.5	10 - 15	185	-
Курка	0.9 - 1.2	40 - 50	180	-

	 (кг)	 (хв.)	 (°C)	
 Закуски				
Фаршировані млинці, заморожені	0.1 - 0.4	8 - 10	200	Потрусіть кошик
Курячі нагетси, заморожені	0.1 - 0.5	6 - 10	200	Потрусіть кошик
Рибні палички, заморожені	0.1 - 0.4	6 - 10	200	-
Сирні закуски у паніровці, заморожені	0.1 - 0.4	8 - 10	180	-
 Випічка				
Торти	0.3	20 - 25	165	Використовуйте форму для випікання
Кіш	0.4	20 - 22	185	Використовуйте форму для випікання / посуд для духовки
Кекс	0.3	15 - 18	200	Використовуйте форму для випікання

6. ПРИМІТКИ ЩОДО ЧИЩЕННЯ

	<p>Засоби для чищення і аксесуари Помийте чашу і кошик м'якою губкою з теплою водою і засобом для миття посуду. Чашу і кошик можна мити у посудомийній машині. Очищуйте нагрівальний елемент щіткою для чищення. Зовнішню поверхню приладу слід протирати м'якою серветкою.</p>	<p>Щоденне користування Перед очищенням від'єднайте прилад від живлення і зачектайте, доки він охолоне. Очищуйте прилад після кожного використання.</p>
--	--	--

7. НЕОБХІДНІ ДІЇ В РАЗІ ВИНИКНЕННЯ ПРОБЛЕМ







Несправність	Перевірте чи...
Прилад не вмикається або не працює.	<ul style="list-style-type: none"> • прилад правильно під'єднано до електромережі. • встановлено час приготування.

Несправність	Перевірте чи...
Не вдається вставити чашу у прилад.	<ul style="list-style-type: none"> • не заповнено кошик понад максимальну місткість. • правильно розташовано кошик, ви маєте почути клацання при встановленні кошика в чашу.
З приладу виходить білий дим.	<ul style="list-style-type: none"> • їжа, яку ви готуєте, не жирна. • чаша і кошик чисті.

8. ТЕХНІЧНІ ДАНІ

8.1 Технічні дані

Напруга	220-240 В
Частота	50 - 60 Гц

		 (درجة مئوية)	 (دقيقة)	 (كجم)	
	-	180	10 - 8	0.4 - 0.1	وجبات خفيفة من الجبن المفروم، مجمد
					 مخبوزات
	استخدام صينية الخبز	165	25 - 20	0.3	كعكات
	استخدام صينية الخبز / صينية تجميصة	185	22 - 20	0.4	فطائر محشوة
	استخدام صينية الخبز	200	18 - 15	0.3	المافين

6. ملاحظات على التنظيف

الاستخدام اليومي	مركبات وملحقات التنظيف
قبل التنظيف، افصل قابس الجهاز وانتظر إلى أن يبرد. نظف الجهاز بعد كل مرة تقوم فيها باستخدام الجهاز.	نظف المقلاة والسلة بالماء الدافئ ووسائل الغسيل وقطعة إسفنج ناعمة. من الآمن وضع المقلاة والسلة في غسالة الأطباق. قم بتنظيف عنصر التسخين باستخدام فرشاة تنظيف. قم بتنظيف الجهاز من الخارج بقماش ناعمة.



7. ماذا تفعل لو...

المشكلة	تحقق مما يلي...
يتعذر عليك تشغيل أو تشغيل الجهاز.	<ul style="list-style-type: none"> الجهاز موصل بالتيار الكهربائي بشكل صحيح. وقت الطهي مضبوط.
يتعذر عليك إدخال المقلاة في الجهاز.	<ul style="list-style-type: none"> السلة غير ممثلة لأكثر من سعتها القصوى. السلة موضوعة بالشكل الصحيح. يجب أن تصدر صوت طقطقة عندما تضعها في المقلاة.
دخان أبيض يخرج من الجهاز.	<ul style="list-style-type: none"> الطعام الذي تحضره غير مدهون بالزيت. المقلاة والسلة نظيفتان.

8. البيانات الفنية

8.1 البيانات الفنية

الجهد الكهربائي	220 - 240 فولت
التردد	50 - 60 هرتز

أفضل قابس الجهاز وانتظر إلى أن يبرد. نظّف المقلاة والسلة.

5. تلميح الطهي

إعدادات درجة الحرارة ومدة الطهي الموضحة في الجداول هي إعدادات إرشادية فقط. وهي تعتمد على الوصفات وعلى نوعية المقادير المستخدمة وكمياتها.

	 (درجة مئوية)	 (دقيقة)	 (كجم)	
 البطاطس والخضروات				
	180	16 - 9	0.7 - 0.3	بطاطس مقلية، ريفية، مجمد
	180	20 - 11	0.7 - 0.3	بطاطس مقلية، سميكة، مجمد
	180	16 - 10	0.8 - 0.3	بطاطس مقلية (8 x 8 مم)
	180	22 - 18	0.8 - 0.3	قطع بطاطا محشوة، طازجة
	180	18 - 12	- 0.3 0.75	مكعبات بطاطس
	170	10	0.4 - 0.1	خضروات محشية
	170	10	0.4 - 0.1	خضراوات
 اللحوم والدواجن				
	200	12 - 8	0.5 - 0.1	شرائح اللحم
	200	14 - 10	0.5 - 0.1	قطع لحم الخنزير
	200	14 - 7	0.5 - 0.1	هامبورجر
	200	15 - 13	0.5 - 0.1	لفائف السجق
	180	22 - 18	0.5 - 0.1	أوراك الدجاج
	185	15 - 10	0.5 - 0.1	صدور الدجاج
	180	50 - 40	1.2 - 0.9	دجاج
 وجبات خفيفة				
	200	10 - 8	0.4 - 0.1	سبرنج رول، مجمدة
	200	10 - 6	0.5 - 0.1	كتل دجاج صلبة، مجمد
	200	10 - 6	0.4 - 0.1	أصابع سمك، مجمد

3. قبل الاستخدام للمرة الأولى

قم بإزالة جميع محتويات العبوة وبطاقات البيانات والغشاء الواقي.



قم بتنظيف السلة والمقلاة بالماء الدافئ وسائل الغسيل وقطعة قماش ناعمة. جفف الجهاز من الداخل والخارج مستخدماً قطعة قماش.



بعد الاستخدام الأول، قد تنطلق من المنتج رائحة غير سامة تختفي على الفور. وهذا لا يؤثر على الاستخدام.



4. الاستخدام اليومي

4.1 كيفية الاستخدام: المقلاة والسلة

ضع الجهاز على السطح المستقر.

1. أخرج المقلاة وضعها على السطح المستقر.
2. قم بإزالة غطاء الحماية الموجود على قفل الأمان.
3. اضغط على قفل الأمان لفك السلة.

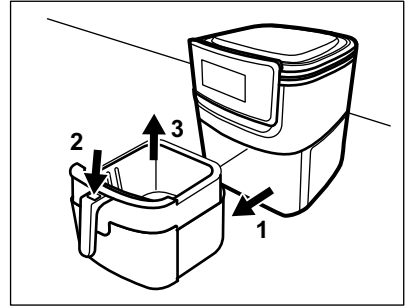

4. ضع الطعام في السلة حتى تصل إلى المستوى الأقصى. السعة القصوى للسلة هي 2 كجم.

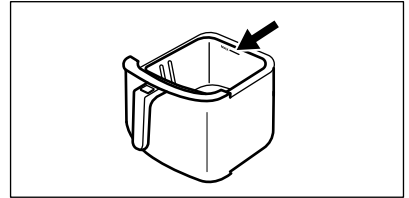

رمز	الإعداد
	140 درجة مئوية 15 دقيقة
	200 درجة مئوية 10 دقائق
	180 درجة مئوية 20 دقيقة
	180 درجة مئوية 45 دقيقة
	170 درجة مئوية 15 دقيقة
	180 درجة مئوية 15 دقيقة
	180 درجة مئوية 10 دقائق
	180 درجة مئوية 15 دقيقة

3. اضغط على: ①

- عندما ينتهي الطهي، تعمل مروحة التبريد لعدة ثوانٍ، ثم يتم إصدار إشارة صوتية. يمكنك تغيير الإعداد وإيقاف الجهاز أثناء الطهي:
- اضغط على رمز الطعام لتغيير البرنامج.
- \wedge ، \vee - اضغط لضبط إعدادات مدة الطهي ودرجة الحرارة.
- ① - اضغط مع الاستمرار لمدة ثوانٍ قليلة لإيقاف الجهاز.

4.2 كيفية الطهي

ضع الطعام في السلة. وصل قابس الجهاز.

1. ① - اضغط واستمر في الضغط.
2. حدد الطبق من الطهي المساعد:

1. نظرة عامة

- 1 عرض
- 2 لوحة التحكم
- 3 السلة
- 4 قفل أمان مع غطاء حماية
- 5 مقلاة

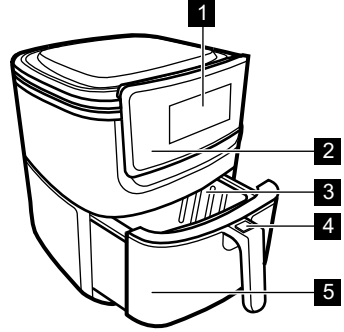

2. لوحة التحكم

2.1 لوحة التحكم

تعرف على الرموز الأساسية الموجودة على لوحة التحكم وعلى الشاشة.				
				
المدة	درجة الحرارة	أسفل	أعلى	التشغيل / إيقاف التشغيل
تقنية Assisted Cooking - الطهي مستخدماً الإعدادات التفانيّة لدرجة الحرارة ومدة الطهي.				
				
دجاج	أوراك الدجاج	شرائح اللحم	السّمك	
				
المافين	بيتزا صغيرة	بطاطس مقلية	خضراوات	

2.2 عرض

- A. إعداد درجة الحرارة
- B. إعدادات مدة الطهي
- C. مدة الطهي / درجة الحرارة

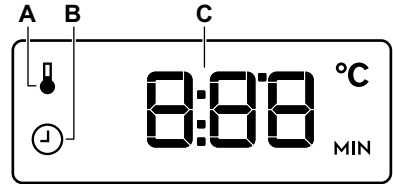



867361838-C-392020